



Results FY 2016 Schaeffler AG

Analyst and Investor Conference Call
March 8, 2017
Herzogenaurach

This presentation contains forward-looking statements. The words "anticipate", "assume", "believe", "estimate", "expect", "intend", "may", "plan", "project", "should" and similar expressions are used to identify forward-looking statements. Forward-looking statements are statements that are not historical facts; they include statements about Schaeffler Group's beliefs and expectations and the assumptions underlying them. These statements are based on plans, estimates and projections as they are currently available to the management of Schaeffler AG. Forward-looking statements therefore speak only as of the date they are made, and Schaeffler Group undertakes no obligation to update any of them in light of new information or future events.

By their very nature, forward-looking statements involve risks and uncertainties. These statements are based on Schaeffler AG management's current expectations and are subject to a number of factors and uncertainties that could cause actual results to differ materially from those described in the forward-looking statements. Actual results may differ from those set forth in the forward-looking statements as a result of various factors (including, but not limited to, future global economic conditions, changed market conditions affecting the automotive industry, intense competition in the markets in which we operate and costs of compliance with applicable laws, regulations and standards, diverse political, legal, economic and other conditions affecting our markets, and other factors beyond our control).

This presentation is intended to provide a general overview of Schaeffler Group's business and does not purport to deal with all aspects and details regarding Schaeffler Group. Accordingly, neither Schaeffler Group nor any of its directors, officers, employees or advisers nor any other person makes any representation or warranty, express or implied, as to, and accordingly no reliance should be placed on, the accuracy or completeness of the information contained in the presentation or of the views given or implied. Neither Schaeffler Group nor any of its directors, officers, employees or advisers nor any other person shall have any liability whatsoever for any errors or omissions or any loss howsoever arising, directly or indirectly, from any use of this information or its contents or otherwise arising in connection therewith.

The material contained in this presentation reflects current legislation and the business and financial affairs of Schaeffler Group which are subject to change.

- 1** Overview
- 2** Financial Results 2016
- 3** Investment Highlights
- 4** Outlook



Key aspects

- 1 Group sales +3.4%¹⁾ based on strong Q4 2016 with sales increase of +5.6%¹⁾ – FY 2016 EBIT margin²⁾ at 12.7% (FY '15: 12.7%)
- 2 Record result in Automotive with sales increase of +6.0%¹⁾ (Q4 '16: +8.2%) – FY 2016 EBIT margin²⁾ at 14.4% (FY '15: 13.8%)
- 3 Industrial sales stabilizing with FY 2016 -4.8%¹⁾ (Q4 '16: -3.2%) – FY 2016 EBIT margin²⁾ at 7.0% (FY '15: 9.5%)
- 4 Strong Free Cash Flow of EUR 735 mn in FY 2016 (FY '15: EUR 370 mn) – Gearing ratio reduced to 132% (FY '15: 312%)
- 5 Proposed regular dividend to rise by 15 cents to 50 cents per share (FY '15: 35 cents³⁾) – EPS increased to EUR 1.30 (FY '15 Pro Forma: EUR 0.97⁴⁾)
- 6 Strategy "Mobility for tomorrow" adopted – Good progress on E-Mobility and Program CORE

1) FX-adjusted

2) Before one-off effects

3) Excluding special dividend of 15 cents

4) Pro Forma calculation based on adjusted 2015 figures

1 Sales growth FY 2016 3.4% (FX-adjusted) – 12.7% EBIT margin before one-offs

Sales

in EUR mn



1) FX-adjusted
2) Before one-off effects

EBIT before one-off effects

in EUR mn

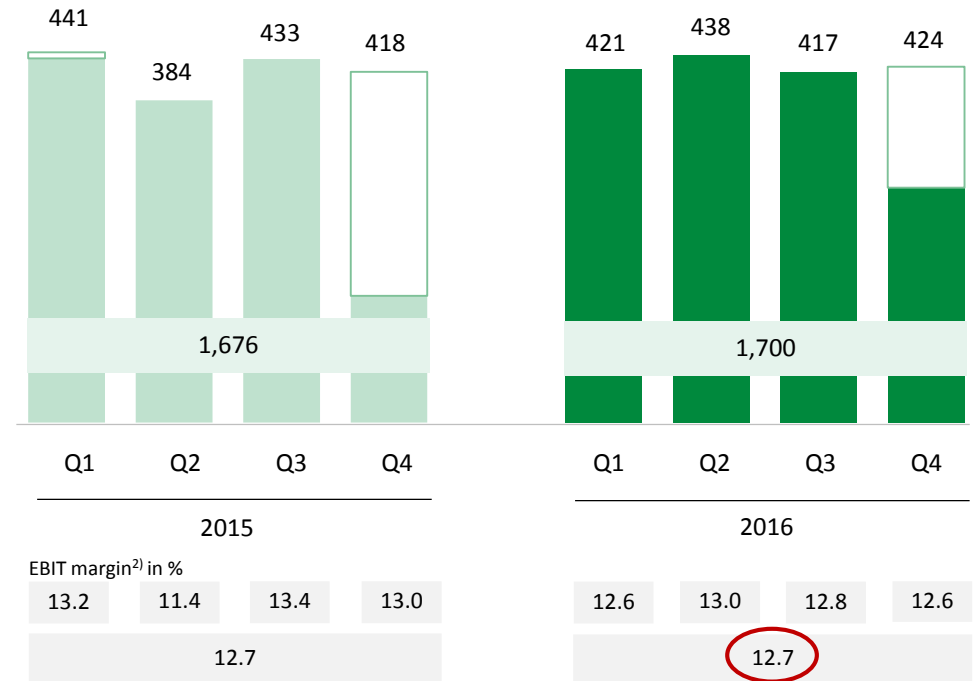

2 Automotive Division – Strong Q4 2016 due to China and Automotive Aftermarket

Sales

in EUR mn

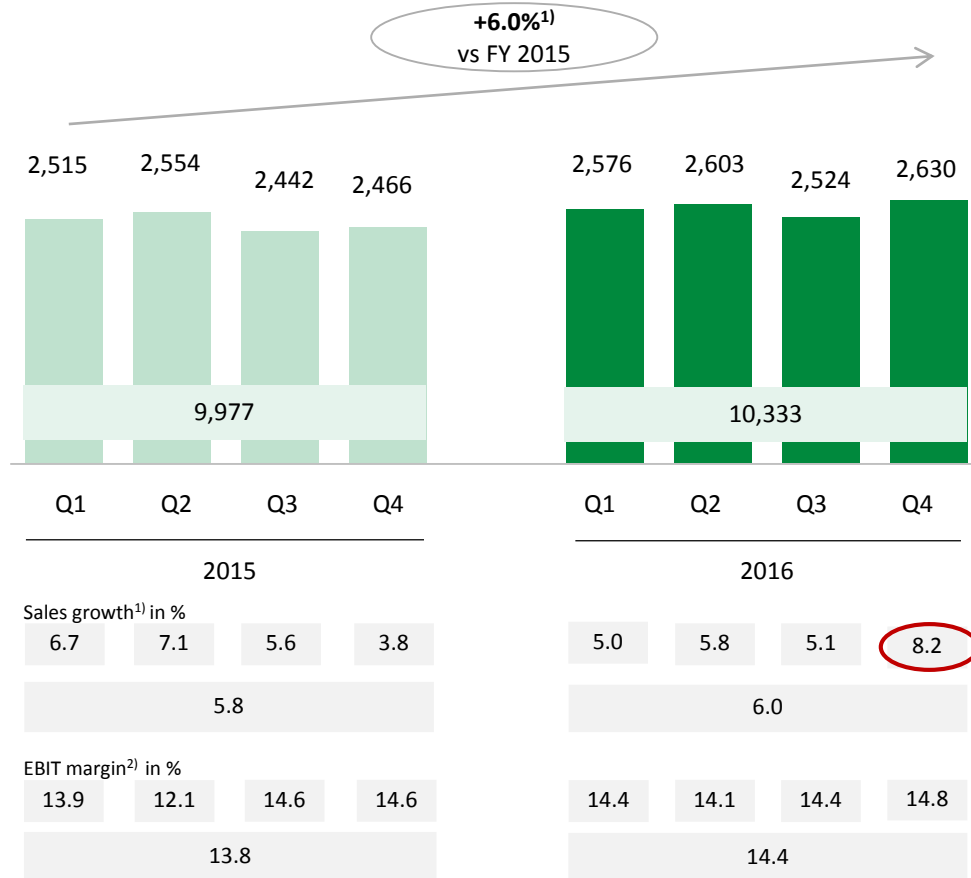

1) FX-adjusted 2) Before one-off effects

Sales by region FY 2016

y-o-y growth¹⁾

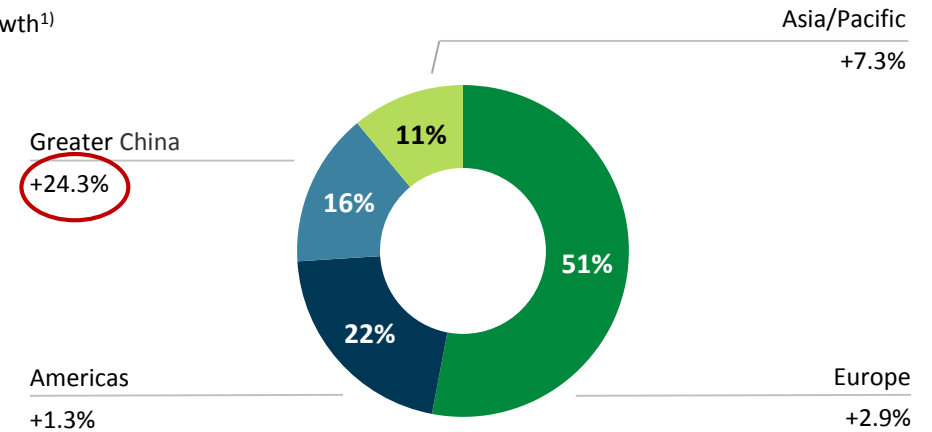

Sales by business division

y-o-y growth (w/o FX effects)

	FY 2015	FY 2016	Δ (w/o FX effects)	Q4 '15	Q4 '16	Δ (w/o FX effects)
Transmission	4,212	4,349	+5.6%	1,062	1,132	+8.3%
Engine	2,595	2,643	+3.3%	649	683	+6.1%
Chassis	1,465	1,531	+6.3%	367	389	+6.7%
Aftermarket	1,705	1,810	+10.8%	388	426	+12.4%
Total	9,977	10,333	+6.0%	2,466	2,630	+8.2%

2 Automotive Division – China as major growth driver

Schaeffler in Greater China



Key aspects

- ▶ 11,000 employees in 8 plants, 1 R&D center, 22 sales offices, new plant in Xiangtan under construction
- ▶ Sales of EUR 2.0 bn in FY 2016, thereof 1.7bn automotive (+24%¹⁾)
- ▶ Increasing share of business with local OEMs
- ▶ Greater China as lead market for E-Mobility (BEV/HEV)

1) FX-adjusted

OEM sales exposure 2016

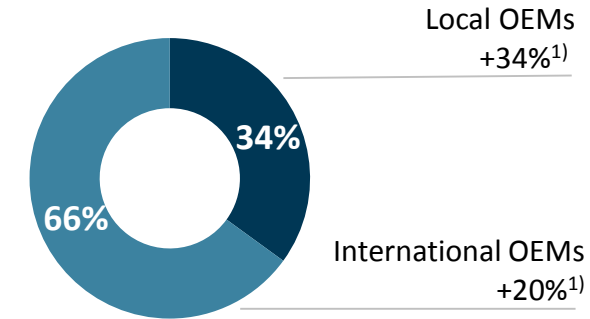

Total Sales: EUR 1,675 mn

Key customers



Sales growth China 2012-2016

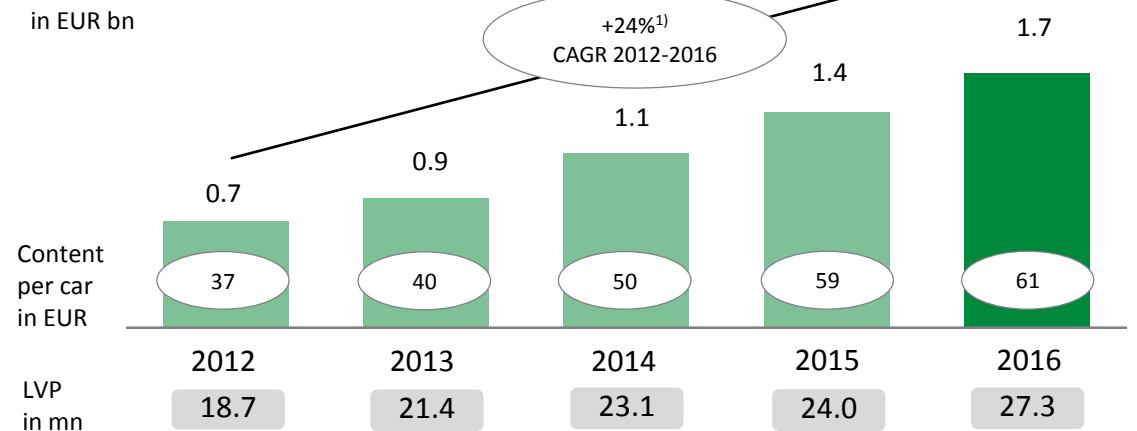

2 Automotive Division – Strong performance in Automotive Aftermarket

Two sales channels, three types of business



- 1 Components business: Traditional business with replacement parts like clutches, bearings and related components. Growth rate similar to global car fleet growth
- 2 Solutions business: Complete sets and kits for one-stop repair solutions. Growing complexity of the cars as well as strong relationships with work shops as main drivers for outperformance
- 3 OES business: Business with automotive manufacturers. Growing focus on the business over last few years with products like double clutches and dual mass flywheels

1) FX-adjusted

Sales exposure 2016

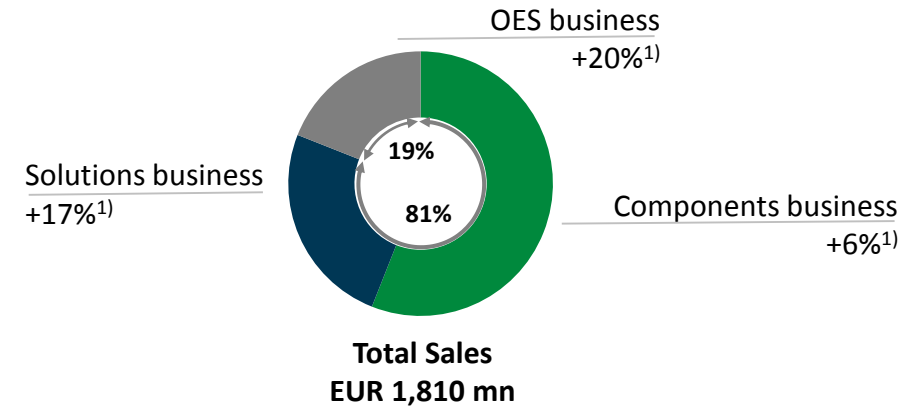

Independent Aftermarket: 81% of sales OES: 19% of sales

Sales growth Automotive Aftermarket 2012-2016

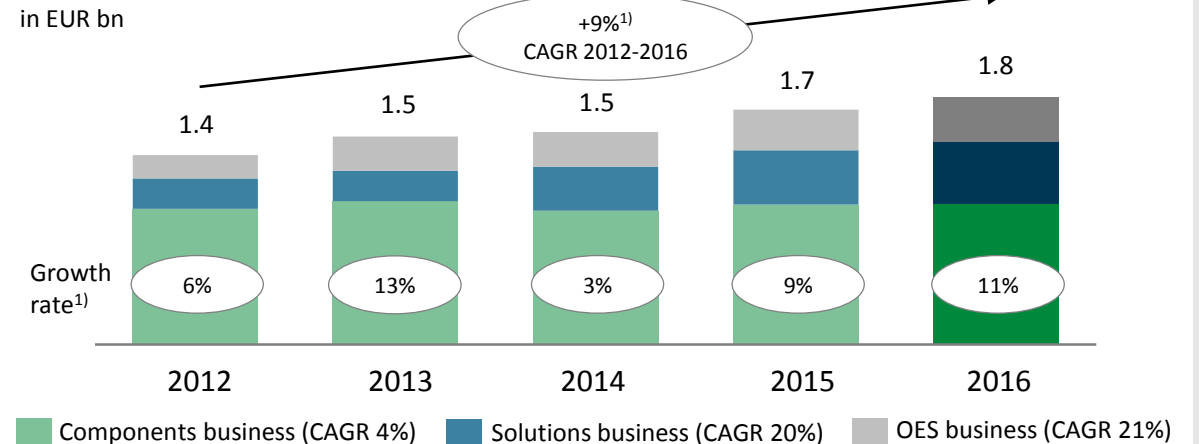

3 Industrial Division – Revenues trend stabilizing

Sales

in EUR mn

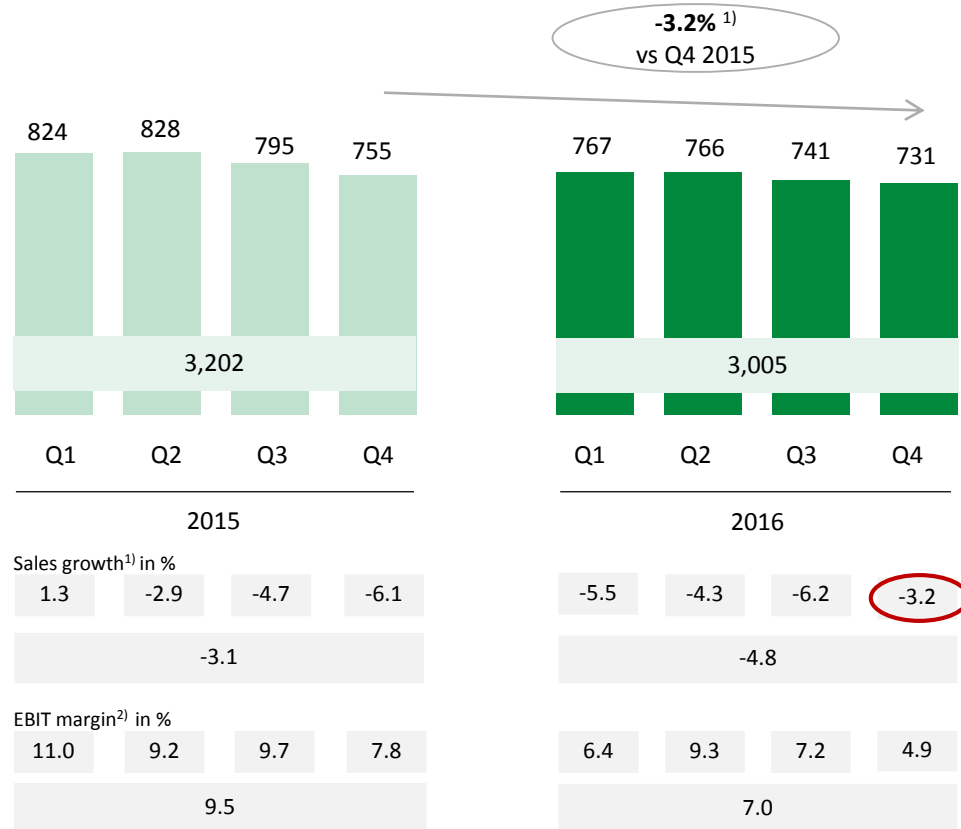

1) FX-adjusted 2) Before one-off effects

Sales by business division

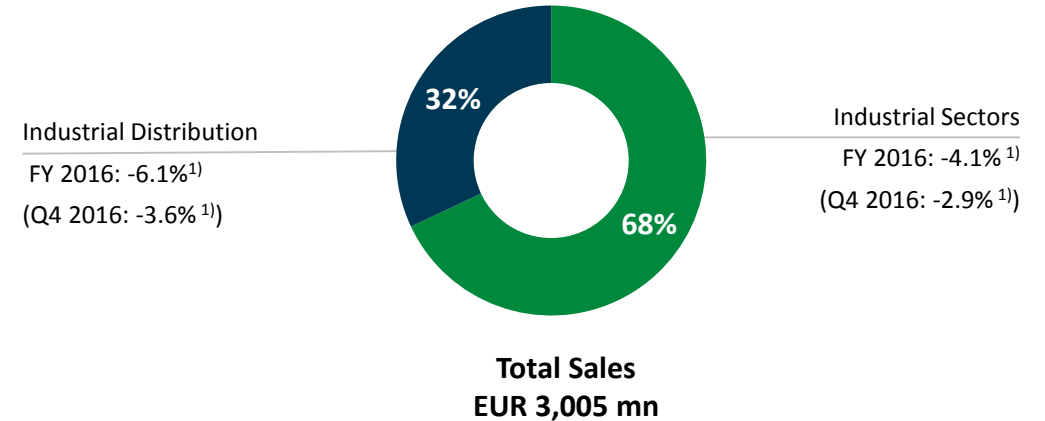

Sales by region

y-o-y growth (w/o FX effects)

	FY 2015	FY 2016	Δ (w/o FX effects)	Q4 '15	Q4 '16	Δ (w/o FX effects)
Europe	1,816	1,773	-1.3%	434	421	-2.3%
Americas	600	562	-4.6%	134	139	+1.5%
Greater China	478	378	-18.8%	117	99	-13.7%
Asia/Pacific	308	292	-4.1%	70	72	+0.0%
Total	3,202	3,005	-4.8%	755	731	-3.2%

3 Industrial Division – EBIT down due to volume, price and mix

EBIT ¹⁾ 2015 vs. 2016

in EUR mn

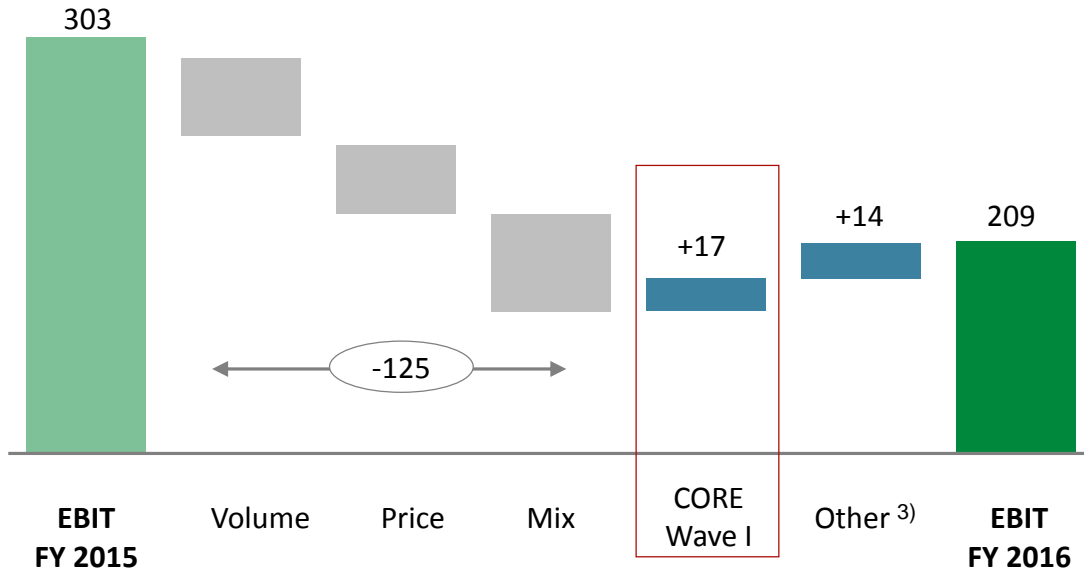

EBIT ¹⁾ margin in % 9.5%

Sales ²⁾ 3,202

7.0%

3,005

1) Before one-off effects 2) FX-adjusted 3) Including FX effects and operational performance

Key aspects

- ▶ Lower EBIT due to negative price, volume and mix impact
- ▶ EBIT margin 7.0% in FY2016 after 9.5% in FY2015
- ▶ CORE program on track, Wave I 95% completed

HCO reduction Overhead

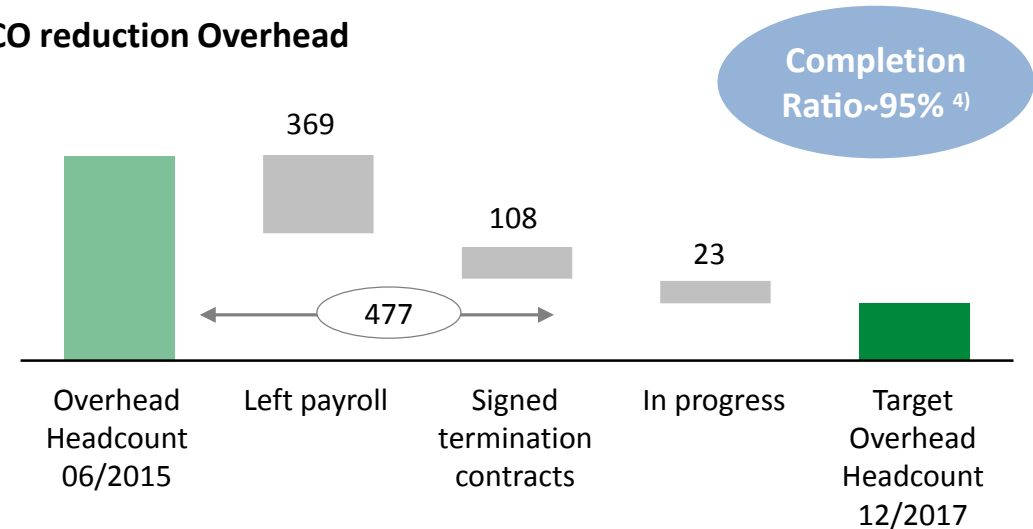

⁴⁾ as of Feb, 2017

3 Industrial Division – CORE Wave II successfully started

Indicative Financial Impact Wave I

in EUR mn

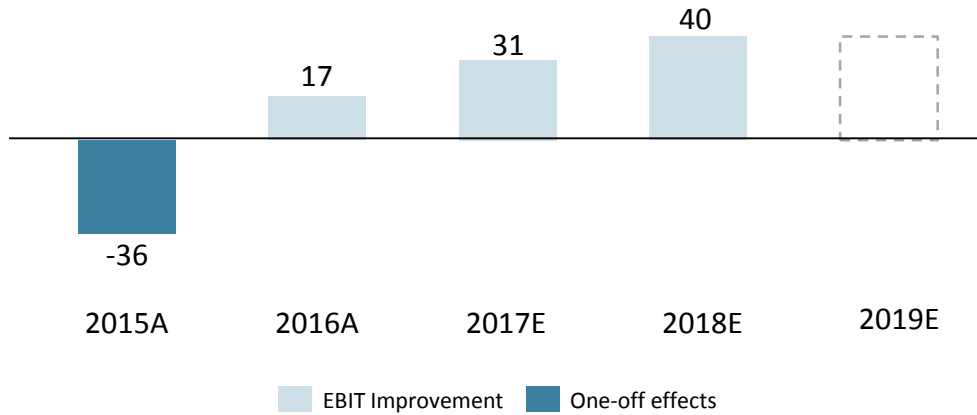

Key aspects

- ▶ CORE Wave II targeting Gross Profit optimization and extended Overhead Cost reduction through consolidation of plants also outside Industrial division
- ▶ First plant closure in Germany agreed with workers council in February 2017
- ▶ Current US situation may change execution plan, overall target remains in place (EUR 60 mn by 2019)

Indicative Financial Impact Wave II¹⁾

in EUR mn

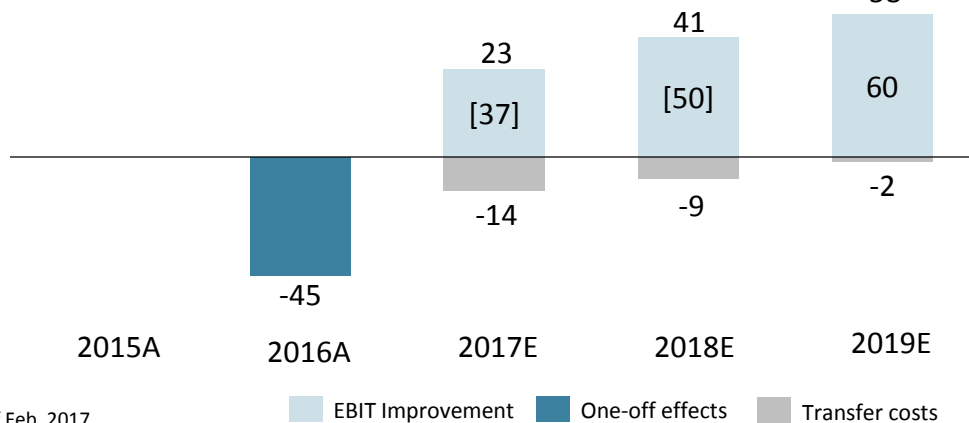

HCO reduction Plants/Overhead

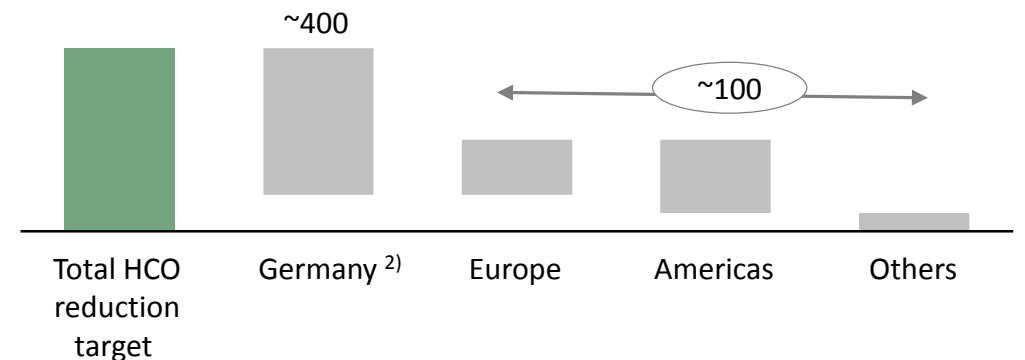

²⁾ Subject to negotiation with workers council

¹⁾ As of Feb, 2017

4 Strong Free Cash Flow generation – FCF conversion ratio improved to 32%

Free Cash Flow

in EUR mn

	FY 2015	FY 2016	Q4 2015	Q4 2016
EBITDA	2,096	2,293	331	476
Net interest paid	-465	-181	-76	-94
Income taxes paid	-358	-327	-111	-93
Working capital	-116	-22	157	281
Others	215	113	159	1
CF from Operations	1,372	1,876	460	571
Capex	-1,025	-1,146	-282	-317
<i>in % of Sales</i>	7.8	8.6	8.8	9.4
Others	23	5	-	2
CF from Investments	-1,002	-1,141	-282	-315
Free Cash Flow	370¹⁾	735	178	256
FCF conversion²⁾	26%	32%	-	-
Cash & cash equivalents	799	1,07	799	1,071

1) Including EUR 173 mn refinancing charges

2) FCF divided by EBITDA; FCF 2015 adjusted for one-time refinancing charges

Key aspects

- ▶ Free Cash Flow increased by EUR 365 mn to EUR 735 mn in FY 2016 in particular due to higher EBITDA and lower interest charges
- ▶ Capex increased to 8.6% of sales in FY 2016 (FY '15: 7.8%)
- ▶ Gearing ratio reduced to 132% (FY '15: 312%)

Net financial debt and leverage ratio

in EUR mn

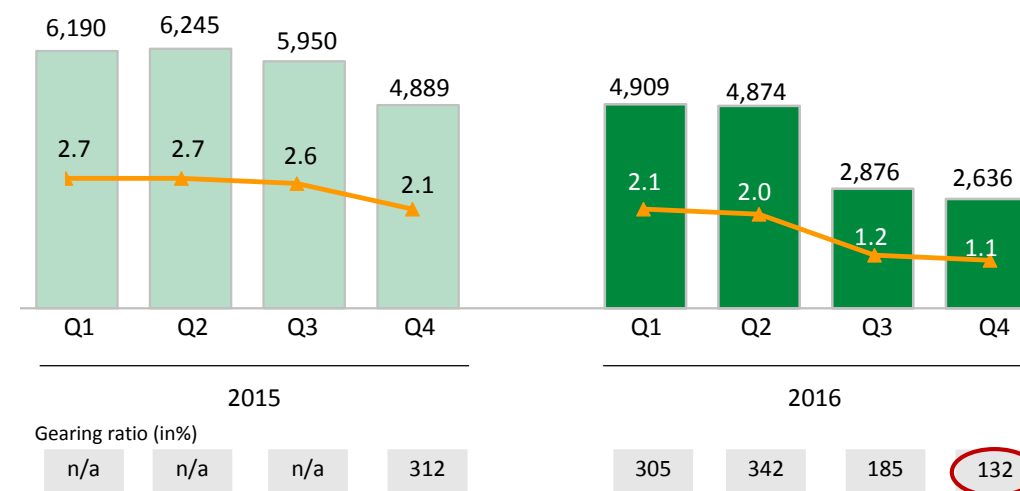

Leverage ratio: Net financial debt / LTM EBITDA before one-off effects

Gearing ratio: Net financial debt / Equity (excluding pensions)

5 EPS increased to EUR 1.30 – Proposed Regular dividend to raise to 50 cents

Net income

in EUR mn

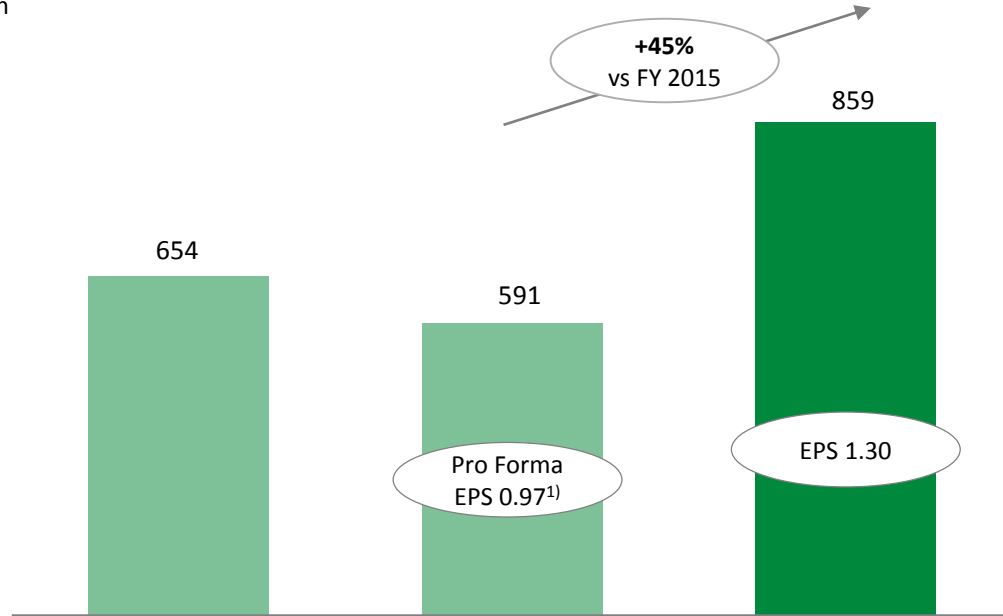

	2014	2015	2016
EPS (as reported)	n/a	1.28 ²⁾	1.30
Number of shares	n/a	116 ³⁾	166

1) Based on proportionate net income of EUR 113m (1 cent preferred dividend + 116/616 of remaining net income) and 116 mn shares (see footnote 3)
 2) Based on proportionate net income of EUR 149m (1 cent preferred dividend + 166/666 of remaining net income) and 116 mn shares (see footnote 3)
 3) 100 mn shares + 66 mn shares issued in October 2015 (100 + 88/365 * 66)

Dividend amount

in EUR mn

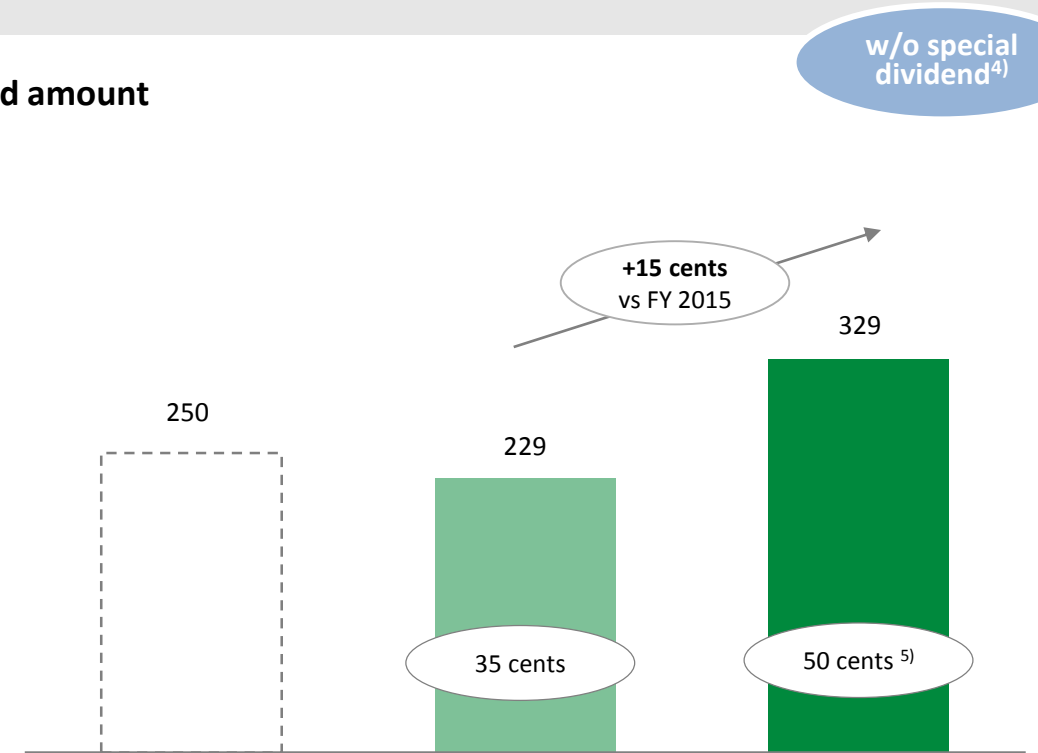

	2014	2015	2016
Payout ratio⁶⁾	n/a	28.9%	34.1%
Dividend policy	n/a	25-35%	30-40%

4) Special dividend of 15 cents per share in FY 2015
 5) Proposed dividend
 6) Absolute dividend amount divided by adjusted net income

Vision / Mission

Mission

"Guided by the values of a global family business, we work closely together with our customers as true partners to deliver a compelling value proposition through our best-in-class expertise in manufacturing technology and systems know-how. In doing so, we contribute to the success of our customers, the advancement of our employees, and the prosperity of our society."

Vision

"As a leader in technology, we combine a passion for innovation with the highest standards of quality to shape the future of mobility – for a world that will be cleaner, safer, and smarter."



4 Focus areas

Eco-friendly drives

- ▶ Optimized combustion engine
- ▶ Electric vehicles
- ▶ Industrial drives



Urban mobility

- ▶ Two-wheelers
- ▶ Inner-city railways
- ▶ Micro mobiles



Mobility for tomorrow

Interurban mobility

- ▶ Rail vehicles
- ▶ Aircraft
- ▶ Off-highway



Energy chain

- ▶ Wind power
- ▶ Solar power
- ▶ Conventional power generation



8 Strategic pillars

- We want to be the preferred technology partner for our customers.
- We are an Automotive and Industrial supplier.
- We are a global company with a local presence throughout the world.
- We produce components and systems.
- We view E-Mobility, Industry 4.0, and Digitalization as key opportunities for the future.
- We strive for the highest possible quality, efficiency, and delivery performance.
- We want to be an attractive employer.
- We live by the values of a global family business.

16 Strategic initiatives

Agenda 4 plus One



Initiatives

Initiatives	Sponsor
1 Customer Excellence	Prof. Pleus / Dr. Spindler
2 E-Mobility	Prof. Gutzmer
3 Industry 4.0	Dr. Spindler
4 Quality for Tomorrow	Rosenfeld
5 Global Footprint	Rosenfeld
6 Factory for Tomorrow	Jung
7 Shared Services	Dr. Hauck
8 Process Excellence	Rosenfeld
9 Working Capital	Dr. Hauck
10 Leadership & Corporate Values	Schittenhelm
11 Qualification for Tomorrow	Schittenhelm
12 New Work	Schittenhelm
13 Program CORE	Dr. Spindler
14 Digital Agenda	Prof. Gutzmer
15 IT 2020	Prof. Gutzmer
16 Global Branding	Rosenfeld

Equity Story – 3 key elements

Automotive growth above market



Margin upside in Industrial



Strong Free cash flow generation

4 key questions

A What is your expectation regarding your Automotive outperformance for 2017?

B Are there any news with regard to e-mobility?

C When will the Industrial margin pick up again?

D What are your priorities with regard to "use of cash"?

A Outperformance 2017 – Strong Q4 2016

Outperformance 2013 – 2017

	Q1 2016	Q2 2016	Q3 2016	Q4 2016	FY 2016
Growth rate Automotive ¹⁾	5.0%	5.8%	5.1%	8.2%	6.0%
Light Vehicle Production ²⁾	1.9%	3.4%	6.8%	7.2%	4.8%
Outperformance	3.1%	2.4%	-1.7%	1.0%	1.2%

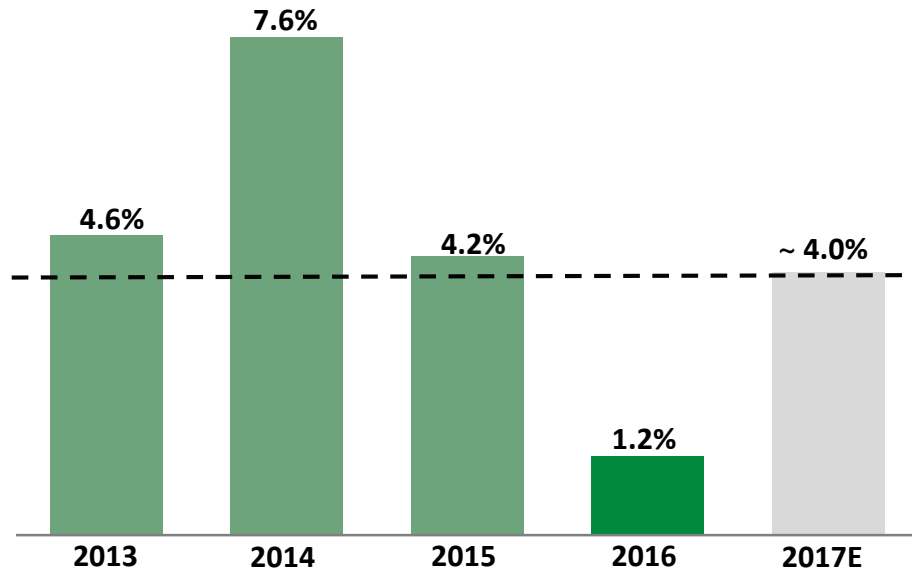

Growth rate Automotive ¹⁾	8.6%	10.7%	5.8%	6.0%	
LVP growth ²⁾	4.0%	3.1%	1.6%	4.8%	1.6%
Light Vehicles in mn ²⁾	84.7	87.4	88.7	93.0	94.5

Automotive sales and market development FY 2016

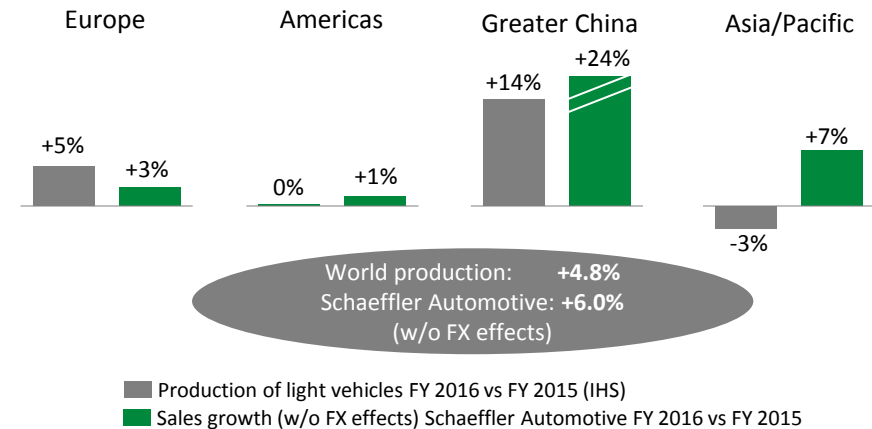

Key aspects

- ▶ Outperformance 2016 of 1.2%-pts due to strong Q4 2016
- ▶ 1.6% Light vehicle production growth in 2017 expected
- ▶ Several high-volume launches coming in 2017

1) Before FX effects 2) Source: IHS, as of February 2017

A Outperformance 2017 – Around 4%-pts above market

Key launches 2017

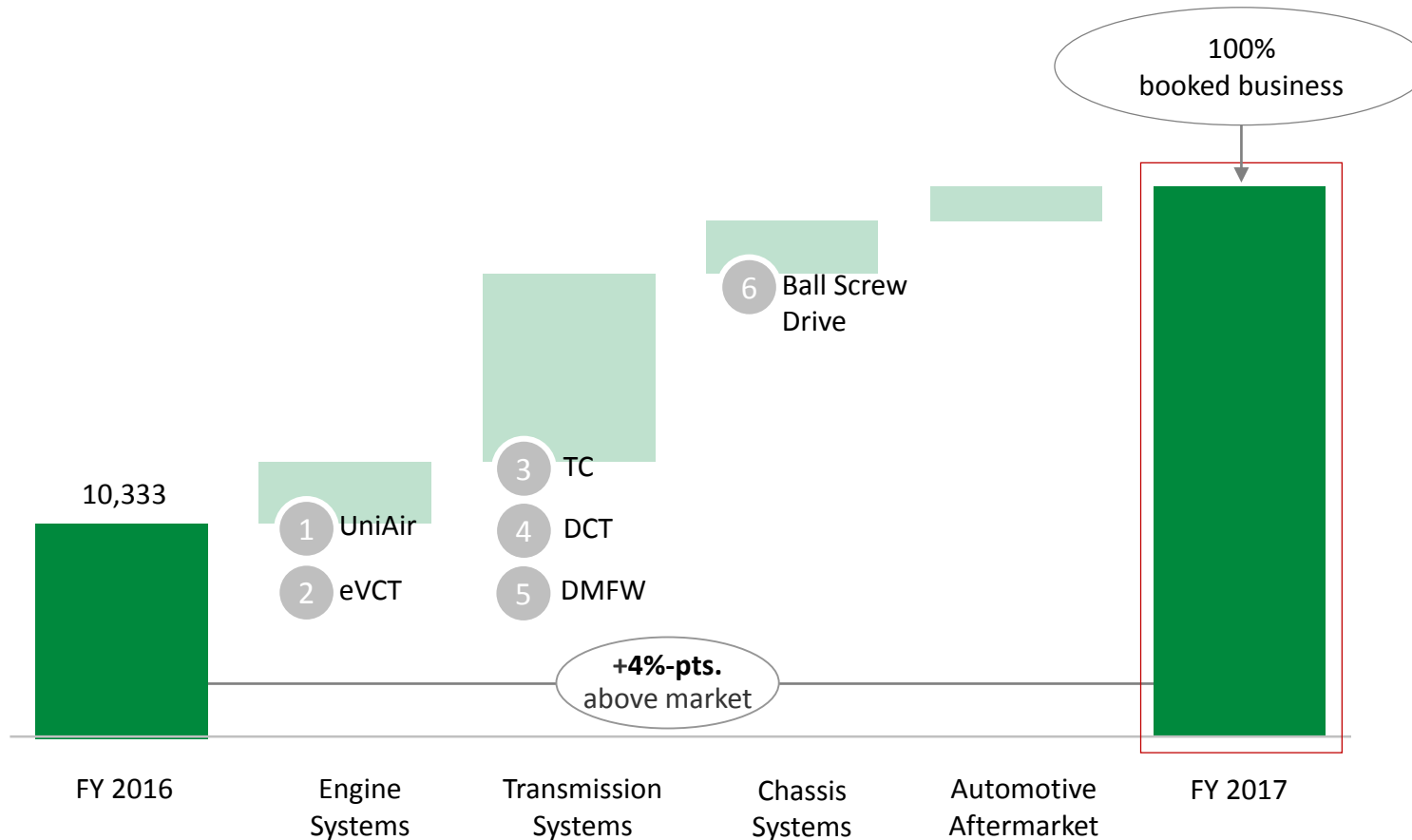

Key drivers

- 1 Ramp-up fully variable valve train system UniAir with Jaguar LandRover
- 2 Ramp-up electromechanical camphaser for Renault-Nissan
- 3 Growing Torque Converter business with Ford and GM in the US as 6 & 8 speed transmissions are replaced by 8 & 10 speed transmissions
- 4 Double-clutch ramp-ups of new projects with local OEMs in China as well as growing market penetration
- 5 Strong growth with Dual Mass Fly Wheels as NVH (noise, vibration and harshness) requirements increase, especially in China
- 6 Growing business with Ball Screw Drives as Tier2 supplier

B E-Mobility – Accelerated scenario becomes more realistic

Global production volume ¹⁾

in millions of units

Basic scenario ²⁾

**CAGR 2010/2030
+2.4% p.a.**

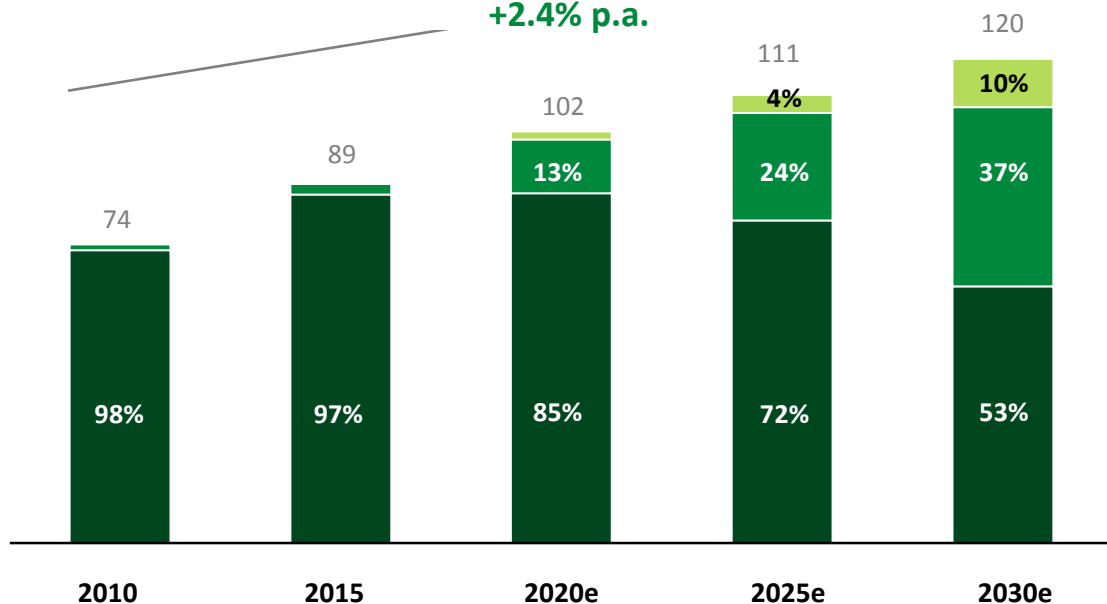

Global production volume ¹⁾

in millions of units

Accelerated scenario ²⁾

**CAGR 2010/2030
+2.4% p.a.**

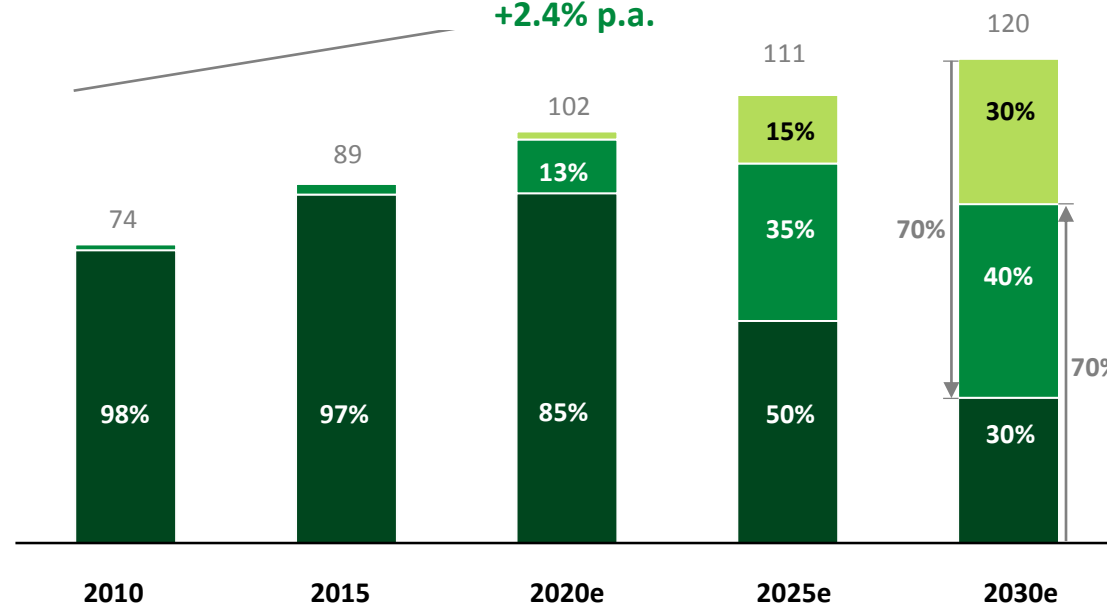

**CO₂ emission regulation,
battery price, charging
infrastructure and customer
behavior as key drivers**

- Battery electric vehicles
- Hybrid vehicles
- Internal combustion engines

Source: IHS, LMC Automotive, Schaeffler Group projections
¹⁾ Annually expected global production volume, automobiles/small utility vehicles in millions of units
²⁾ Schaeffler estimates

B E-Mobility – Broad portfolio of solutions

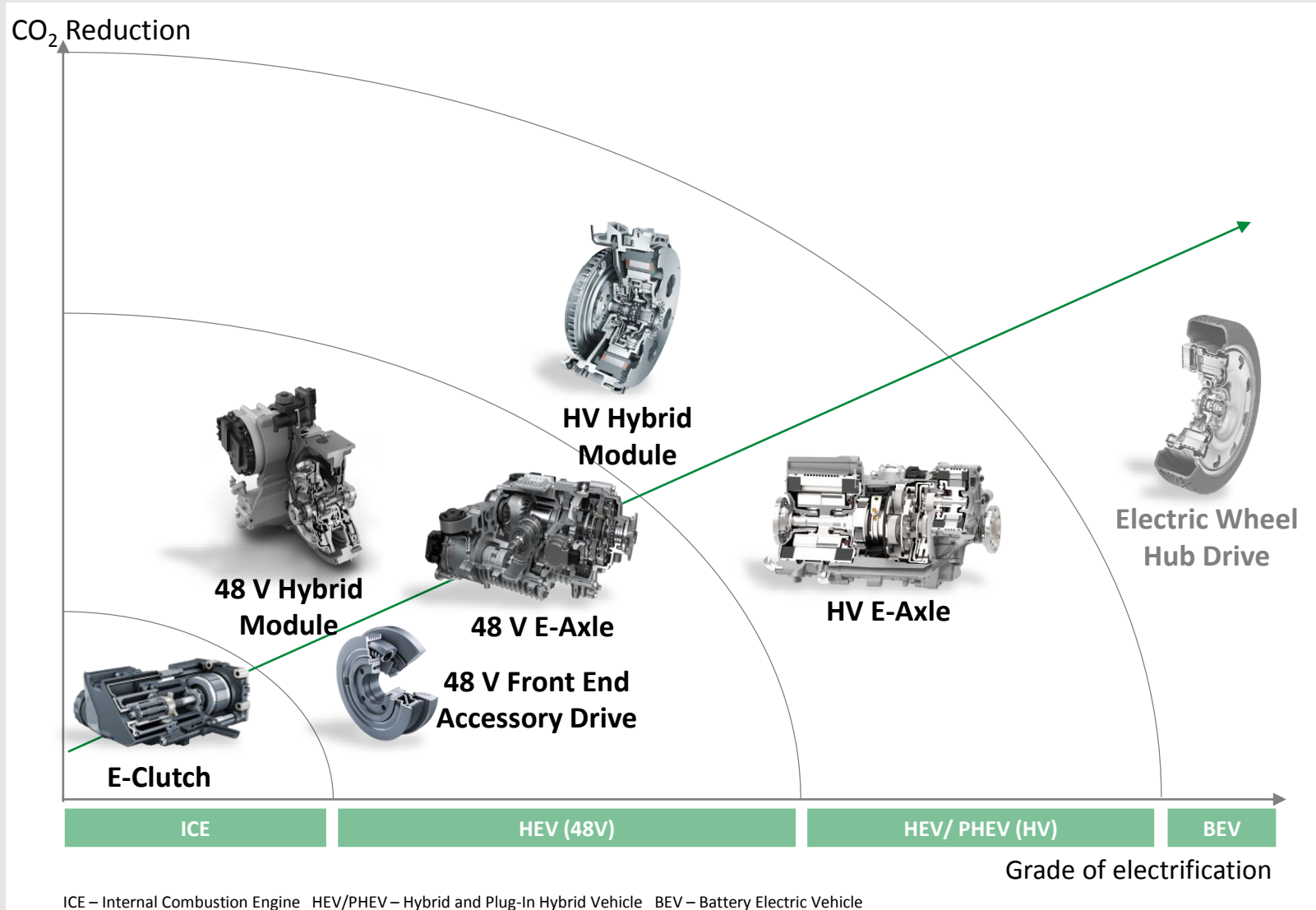

Key aspects

- ▶ Schaeffler with a broad powertrain product portfolio ranging from mild hybrid to full battery electric vehicle solutions
- ▶ More than ten years of experience with E-Mobility solutions
- ▶ 500 Million Euro investment to date¹⁾, 1,200 employees globally
- ▶ 23 active customer projects (48V / High Voltage), 6 series contracts for Hybrid Modules and E-Axles (High Voltage)
- ▶ Further 500 Million Euro investment¹⁾ and doubling of employees in R&D and manufacturing until 2020

Transformation ongoing

¹⁾ Including R&D

B E-Mobility – E-Clutch, 48V mild and high voltage hybridization

ICE

Schaeffler E-Clutch

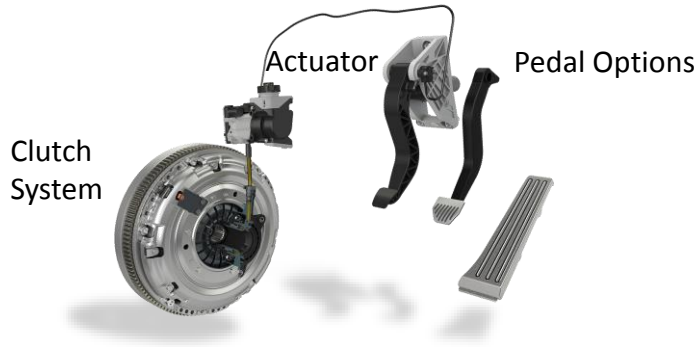

- ▶ Schaeffler E-Clutch¹ paves the way for hybridization of manual transmissions (>40 mn cars produced world wide in 2025)
- ▶ CO₂ reduction of up to 8 % possible at low cost
- ▶ 6 customer projects ongoing, 2 series contracts signed, first SOP 2018

Content per Vehicle
80 – 240 Euro²⁾

¹⁾ Three E-Clutch solutions available ²⁾ Best estimate for additional content

HEV

Schaeffler 48 V Solutions

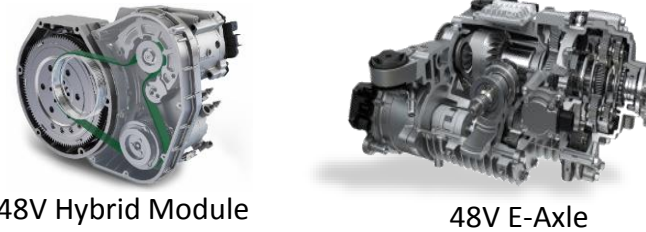

- ▶ Schaeffler as Tier 2 Supplier in 48V P0 solution (1st Gen)
- ▶ Own Tier 1 solution for 48V P2/P4 (2nd Gen), CO₂ reduction of up to 17 % possible
- ▶ 7 customer projects, series contract in the near future

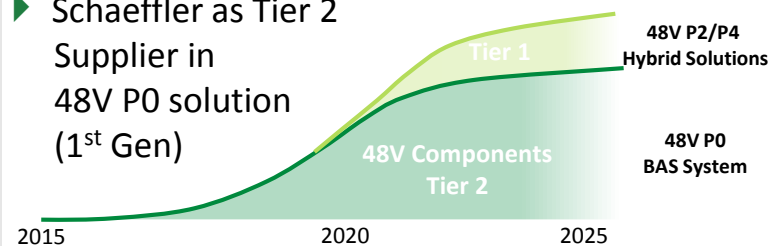

Content per Vehicle₂₀₂₀
20 – 950 Euro²⁾

HEV/BEV

Schaeffler High Voltage Solutions

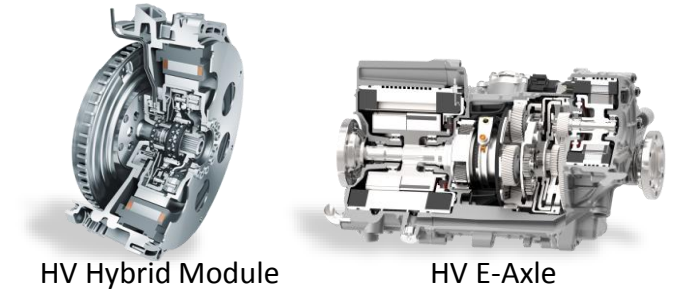

- ▶ Schaeffler offers high voltage Hybrid Modules and E-Axles for hybrid, plug in hybrid and full electric vehicles
- ▶ Enables CO₂ neutral driving in battery electric vehicles and offers benefit of up to 25 % in hybrid and 65 % in plug in hybrid vehicles
- ▶ 16 customer projects, 6 series contracts signed, first SOP 2018

Content per Vehicle₂₀₂₀
300 – 1,250 Euro²⁾

B E-Mobility – Key performance indicators to manage transition

	2015	2016	Target 2020
Market Development¹⁾ in Vehicles '000	<ul style="list-style-type: none"> ▶ BEV 360 ▶ HEV 2,102 ▶ ICE 86,274 	<ul style="list-style-type: none"> ▶ BEV 572 (0.6%) ▶ HEV 2,865 (3.1%) ▶ ICE 89,561 (96.3%) 	
Sales in EUR '000	<ul style="list-style-type: none"> ▶ BEV 3,484 ▶ HEV 197,591 ▶ ICE 8,106,338 	<ul style="list-style-type: none"> ▶ BEV 8,372 (0.1%) ▶ HEV 291,636 (3.4%) ▶ ICE 8,223,497 (96.5%) 	<ul style="list-style-type: none"> ▶ # BEV > 2,000 ▶ # HEV > 13,000
Order Book³⁾ HEV/BEV	<ul style="list-style-type: none"> ▶ Projects⁴⁾ 11 ▶ Series Contracts ▶ Lifetime Sales - 	<ul style="list-style-type: none"> ▶ Projects⁴⁾ 23 ▶ Series Contracts 6 ▶ Lifetime Sales ~EUR 750 mn 	<ul style="list-style-type: none"> ▶ HEV + BEV Sales > 15% of total Sales of Schaeffler Automotive²⁾
Resources	<ul style="list-style-type: none"> ▶ Capex EUR 10 mn ▶ R&D Invest N/A ▶ ΔHCO +163 	<ul style="list-style-type: none"> ▶ Capex EUR 29 mn ▶ R&D Invest EUR 35 mn ▶ ΔHCO +259 	<ul style="list-style-type: none"> ▶ Resources EUR 500 mn add. invest⁵⁾ add. 1,200 ΔHCO

w/o AAM²⁾

1

2

3

¹⁾ IHS Light Vehicle Production Forecast, Feb 2017

²⁾ Excluding Aftermarket

³⁾ Only Hybrid Modules and E-Axes

⁴⁾ Only ongoing Customer Project

⁵⁾ Including R&D and Capex

c Industrial margin – When will the margin pick up again?

EBIT¹⁾ development 2016 – 2018

in EUR mn

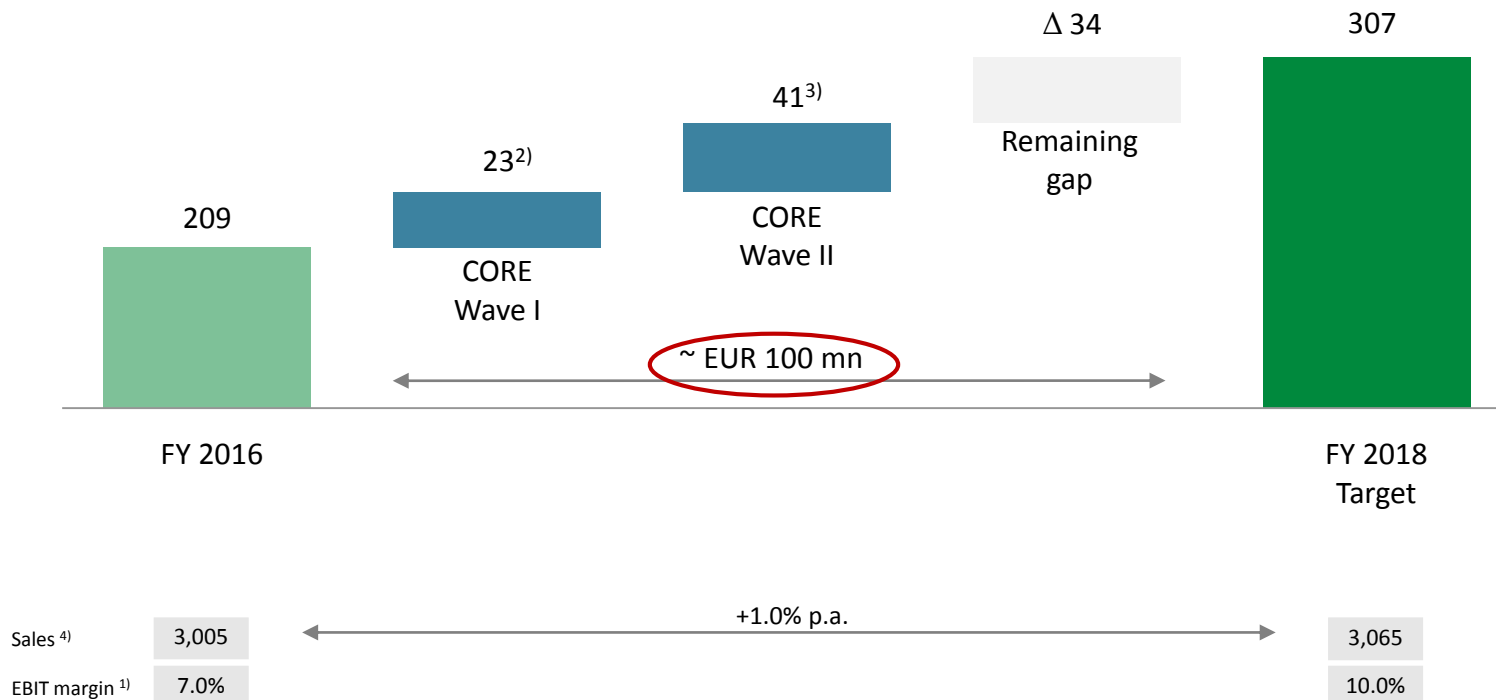

1) Before one-off effects 2) Delta of already achieved EBIT improvement in FY 2016 (EUR 17 mn) and overall effect of EUR 40 mn in 2018
 3) Cumulated net effect (EUR 50 mn EBIT improvement - EUR 9 mn one-off costs) in FY 2018 4) FX-adjusted

Key aspects

- ▶ EBIT gap of around EUR 100 mn due to lower FY2016 EBIT level
- ▶ CORE Wave I and Wave II on track to deliver EUR 64 mn contribution to EBIT
- ▶ Remaining EBIT gap of EUR 34 mn to be closed through volume growth, better mix and, if necessary, additional measures

EBIT margin 2018
 10-11% aggressive, but
 still achievable

C Industrial Division – New business picking up

Wind

Example 1

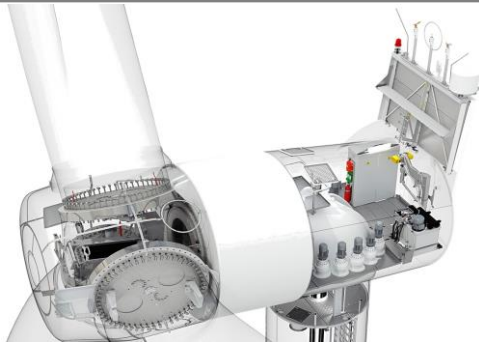

- ▶ Coated tapered and cylindrical roller bearings for wind transmission
- ▶ Region: Europe, Americas, China, Asia/Pacific

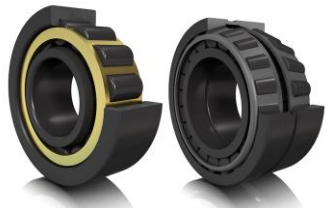

Signed 12/2016

2-year contract
Two-digit Euro mn

Power Transmission

Example 2



- ▶ Standard and customized bearings for hydraulic pumps & motors
- ▶ Region: Europe & Americas



Signed 01/2017

3-year contract
Two-digit Euro mn

Industrial Automation

Example 3



- ▶ Bearings for machine tool applications incl. Industry 4.0 solutions
- ▶ Region: Europe & Asia/Pacific



Signed 02/2017

3-year contract
Two-digit Euro mn

D Use of cash – Balanced approach

Use of cash

in EUR mn

	2014A	2015A	2016A	Guidance 2017
FCF w/o External Growth	48	370	735	~600
3 External Growth	0	0	0	?
FCF	48	370	735	
<hr/>				
Financing activities	Financing proceeds ¹⁾	298	1,214	1,773
	1 Dividends	-1	-251	-329 ²⁾
	2 Deleveraging FCF	0	-250	-125
	Deleveraging IPO / LNR ³⁾	0	-1,007	-1,773
	Other	-26	82	-12
	Total financing activities	271	-212	-466
<hr/>				
Effects FX changes on cash	17	5	3	
Δ Cash	336	163	272	
Cash Balance BOP	300	636	799	
Cash Balance EOP	636	799	1,071	
Capex	857	1,025	1,146	
Leverage ratio ⁴⁾	2.6x	2.1x	1.1x	

Use of cash priorities

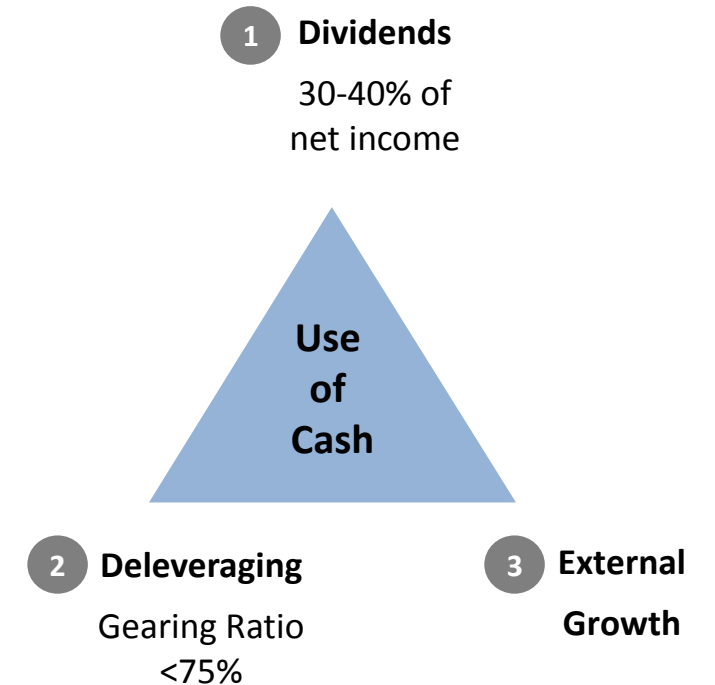

- 1) Net proceeds external debt financing and equity financing plus proceeds from prepayment of loan note receivables
- 2) Including Special dividend of EUR 100 mn
- 3) Deleveraging attributable to IPO proceeds and prepayment loan note receivables
- 4) Net financial debt / LTM EBITDA before one-off effects

Strong results 2016 - On track to reach Financial Ambitions 2020

	FY 2015	Guidance FY 2016	FY 2016	Guidance FY 2017	Financial Ambitions 2020
Sales Growth	+3.5% FX-adjusted	3-4%	+3.4% FX-adjusted	4-5%	Ø 4-6% p.a. w/o external growth, FX-adjusted
EBIT Margin	12.7% Before one-off effects	12-13%	12.7% Before one-off effects	12-13%	12-13% p.a. Before one-off effects, w/o external growth
Free Cash flow	EUR 370 mn	EUR ~600 mn	EUR 735 mn	EUR ~600 mn	~EUR 900 mn w/o external growth
Earnings per Share	EUR 0.97 ¹⁾		EUR 1.30		~EUR 2.00 w/o external growth
Gearing ratio ²⁾	312%		132%		<75%
Dividend ³⁾	28.9% of Net income		34.1% of Net income		30-40% of Net income

Market assumptions

- ▶ Automotive: Growth of global passenger car production of around 2%
- ▶ Industrial: Low single-digit growth of industrial production

1) Pro Forma EPS 2) Net-debt to equity ratio (excluding pensions) 3) Payout ratio based on Net income





Investor Relations

Phone: + 49 9132 82 4440
Email: ir@schaeffler.com
Web: www.schaeffler.com/ir

Financial Calendar

Annual General Meeting:	April 26, 2017
Q1 2017 results:	May 11, 2017
Capital Markets Day:	July 20, 2017
H1 2017 results:	August 8, 2017
9M 2017 results:	November 8, 2017

in EUR mn		FY '15	FY '16	FY '16 vs. FY '15	Q4 '15	Q4 '16	Q4 '16 vs. Q4 '15
Sales	1	13,179	13,338	+1.2% +3.4% ¹⁾	3,221	3,361	+4.3% +5.6% ¹⁾
EBIT		1,676 ²⁾	1,700 ²⁾	+1.4%	418 ²⁾	424 ²⁾	+1.4%
		1,402	1,556	+154 mn	151	280	+129 mn
EBIT margin		12.7% ²⁾	12.7% ²⁾	+0.0%-pts.	13.0% ²⁾	12.6% ²⁾	-0.4%-pts.
		10.6%	11.7%	+1.1%-pts.	4.7%	8.3%	+3.6%-pts.
Net income	2	591	859	+268 mn	70	187	+117 mn
Capex	3	1,025	1,146	+121 mn	282	317	+35 mn
Free cash flow		370	735	+365 mn	178	256	+78 mn
Net financial debt³⁾	4	4,889	2,636	-2,253 mn	4,889	2,636	-2,253 mn
Gearing ratio ^{2) 3)}	4	312%	132%	-180%-pts	312%	132%	-180%-pts
ROCE²⁾	5	22.5%	21.7%	-0.8%-pts.	22.5%	21.7%	-0.8%-pts.
EPS⁴⁾	6	1.28	1.30	+0.02	0.11	0.28	+0.17
Pro Forma EPS⁵⁾		0.97	1.30	+0.33	0.11	0.28	+0.17

1) FX-adjusted

2) Before one-off effects

3) Prior year figure as per December 31, 2015

4) As reported according to IAS 33; see backup chart for further information

5) Share of net income for 66 mn non-voting shares issued through capital increase in October 2015 was calculated for each quarter on a pro-rata temporis basis; see backup chart for further information

1 Sales by region, business division and sector cluster

Automotive sales growth¹⁾ by region

	Q1 '16	Q2 '16	Q3 '16	Q4 '16	FY '16
Europe	+0.9%	+6.6%	+0.2%	+3.9%	+2.9%
Americas	+1.9%	+2.9%	-1.2%	+1.6%	+1.3%
Greater China	+17.0%	+11.6%	+38.9%	+29.9%	+24.3%
Asia/Pacific	+19.1%	0.7%	+3.7%	+6.8%	+7.3%
Total	+5.0%	+5.8%	+5.1%	+8.2%	+6.0%

Sales growth¹⁾ by business division

	Q1 '16	Q2 '16	Q3 '16	Q4 '16	FY '16
Transmission Systems	+6.2%	+3.4%	+4.4%	+8.3%	+5.6%
Engine Systems	+0.3%	+4.6%	+2.4%	+6.1%	+3.3%
Chassis Systems	+4.8%	+8.4%	+5.3%	+6.7%	+6.3%
Aftermarket	+9.8%	+11.3%	+9.8%	+12.4%	+10.8%
Total	+5.0%	+5.8%	+5.1%	+8.2%	+6.0%

1) FX-adjusted

Industrial sales growth¹⁾ by region

	Q1 '16	Q2 '16	Q3 '16	Q4 '16	FY '16
Europe	-1.9%	+1.5%	-2.4%	-2.3%	-1.3%
Americas	-7.4%	-7.1%	-4.7%	+1.5%	-4.6%
Greater China	-18.4%	-21.6%	-21.1%	-13.7%	-18.8%
Asia/Pacific	-3.8%	-6.0%	-6.3%	+0.0%	-4.1%
Total	-5.5%	-4.3%	-6.2%	-3.2%	-4.8%

Sales growth¹⁾ by sector cluster

	Q1 '16	Q2 '16	Q3 '16	Q4 '16	FY '16
Industrial Applications	-3.9%	-2.7%	-7.0%	-2.9%	-4.1%
Industrial Distribution	-8.7%	-7.8%	-4.2%	-3.6%	-6.1%
Total	-5.5%	-4.3%	-6.2%	-3.2%	-4.8%

2 Net income of EUR 859 mn in FY 2016

Net income¹⁾

in EUR mn

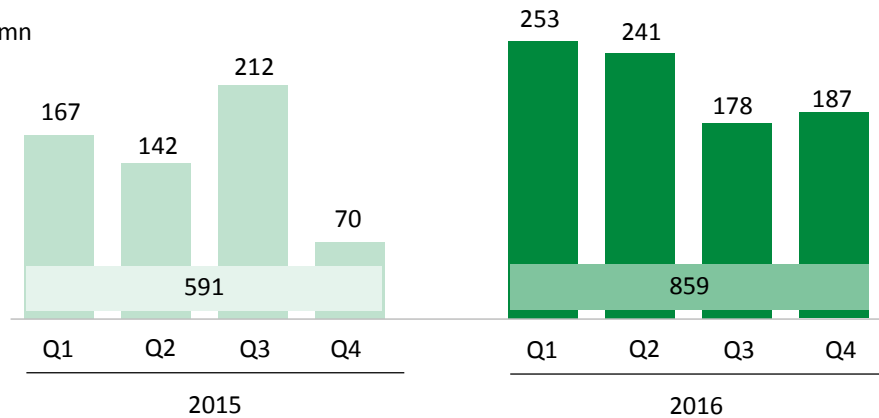

Financial result²⁾

in EUR mn

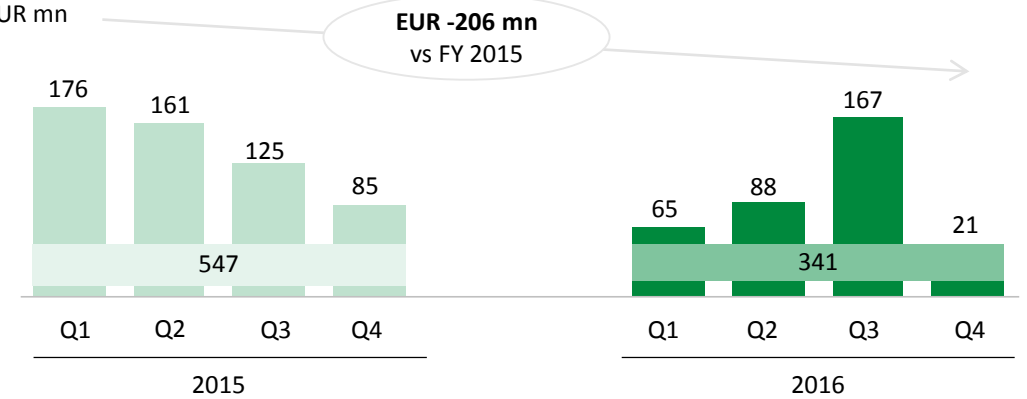

2) For presentation purposes negative results are shown as positive figures

Net income¹⁾ FY 2016 vs. FY 2015

in EUR mn

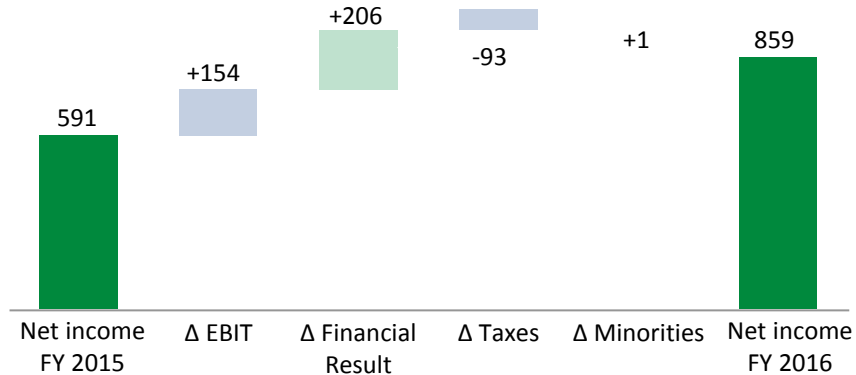

1) Attributable to the shareholders of the parent company

in EUR mn	12M 15	12M 16	Δ	Q4 15	Q4 16	Δ
Cash interest	255	167	-88	83	53	-30
Accrued interest	41	30	-11	-18	-19	-1
Other	-24	35	+59	-8	5	+13
Financial Result excl. one-offs and valuation effects	272	232	-40	57	39	-18
Non-cash valuation effects	79	-49	-128	26	-18	-44
One-off effects refinancing	196	158	-38	2	0	-2
Reported Financial Result	547	341	-206	85	21	-64

3 Working Capital ratio optimized – Capex ratio 8.6%

Working capital¹⁾

in EUR mn

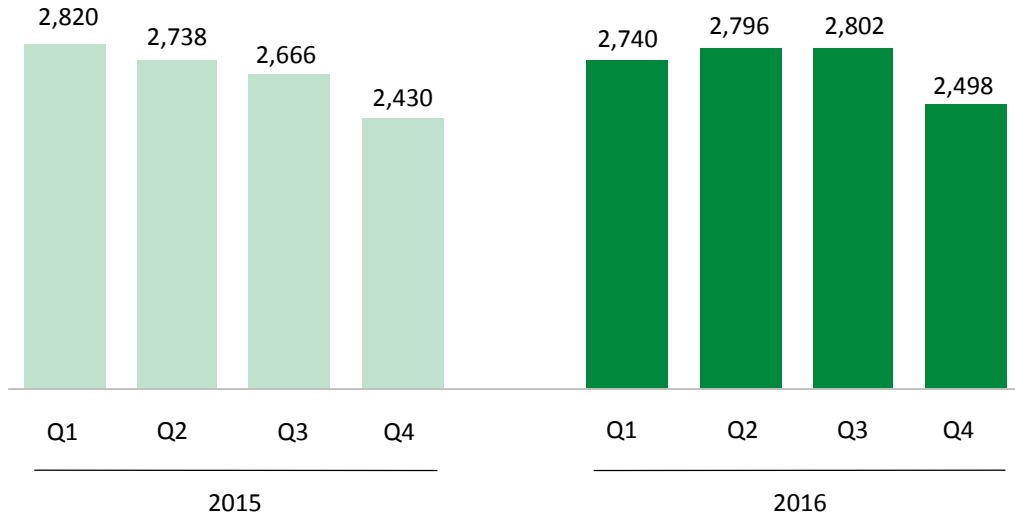

In % of sales



1) According to balance sheet; figures as per the end of period

Capex²⁾

in EUR mn

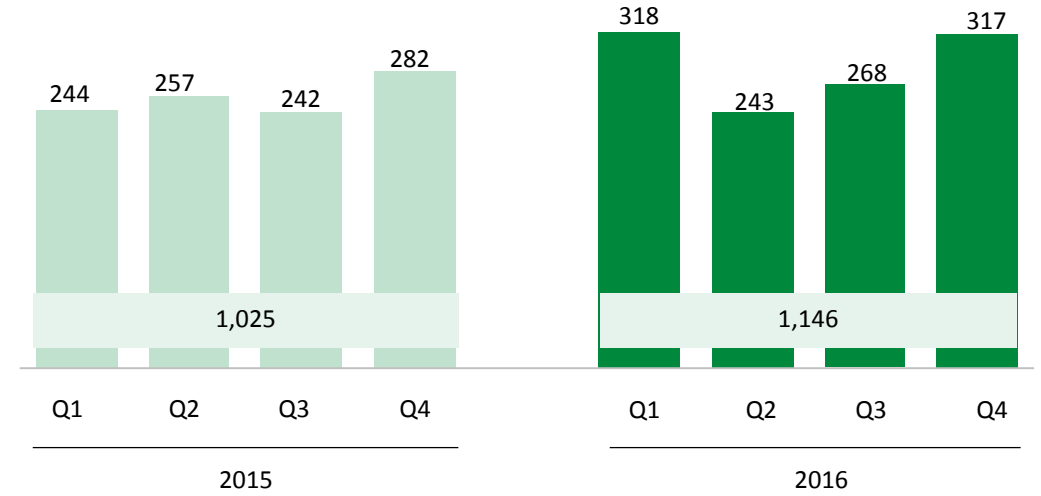

In % of sales



2) Cash view

4 Leverage ratio FY 2016 1.1x – Gearing ratio at 132%

Net financial debt and leverage ratio

in EUR mn

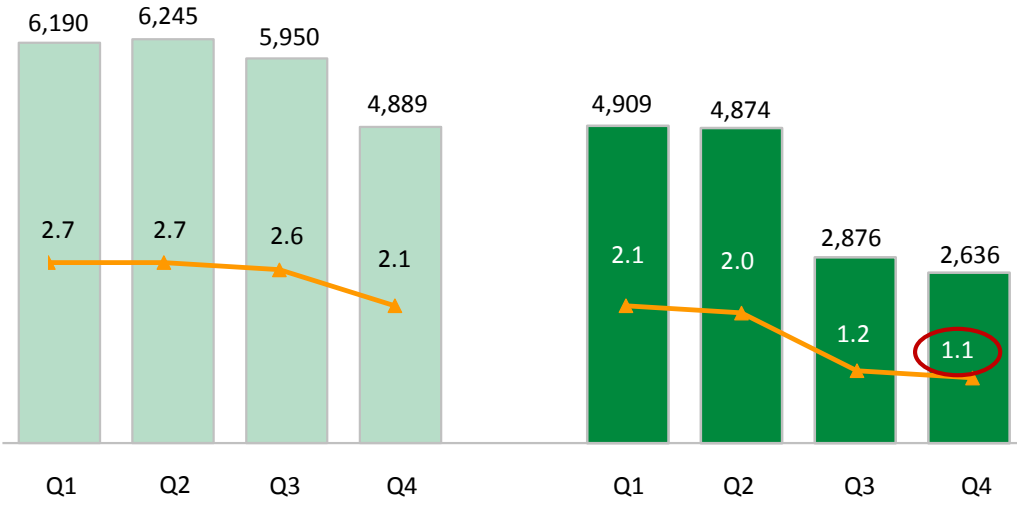

	2015				2016			
Gross debt	6,799	6,665	6,674	5,688	5,602	5,446	5,441	3,707
Cash & cash equivalents	609	420	724	799	693	572	2,565	1,071
Gearing ratio (in%)	1,480	1,174	943	312	305	342	185	132

Leverage ratio: Net financial debt / LTM EBITDA before one-off effects

Gearing ratio: Net financial debt / Equity (excluding pensions)

Change in net financial debt

in EUR mn

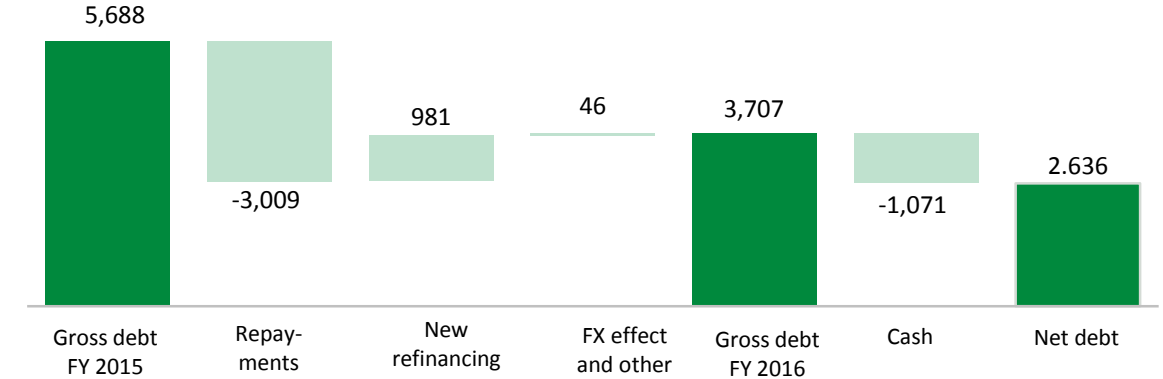

Gearing ratio

	31/12/2015	31/12/2016
Gross debt (in EUR mn)	5,688	3,707
- Cash (in EUR mn)	799	1,071
= Net financial debt (in EUR mn)	4,889	2,636
/ Equity ¹ (in EUR mn)	1,568	1,997
= Gearing Ratio	312%	132%

Schaeffler Value Added ¹⁾

in EUR mn

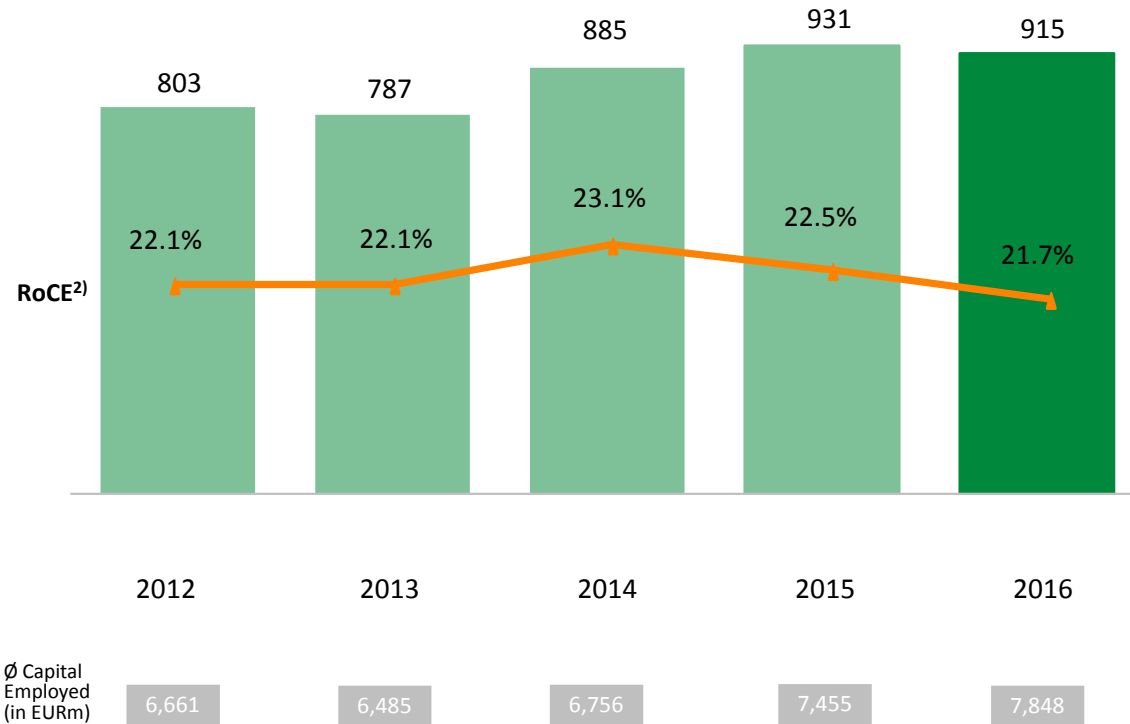

1) Defined as EBIT minus Cost of Capital (10% * ∅ Capital Employed)

2) Before one-off effects

Key aspects Schaeffler Value Added

- ▶ Schaeffler Value Added ¹⁾ measures internal value creation on a group-wide basis
- ▶ Schaeffler Value Added 2016 of EUR 915 mn slightly below prior year (EUR 931 mn) because of higher capital expenditures
- ▶ Cost of Capital: 10% (pre-tax)

Key aspects RoCE ³⁾

- ▶ RoCE measures capital efficiency on a pre-tax basis
- ▶ RoCE at 21.7% in FY 2016 (prior year: 22.5%)
- ▶ Capital Employed increased by 5.3% driven by 12% increase in capital expenditures in 2016

3) Defined as EBIT / ∅ Capital Employed

6 Earnings per share

Earnings per common non-voting share (as reported)

in EUR

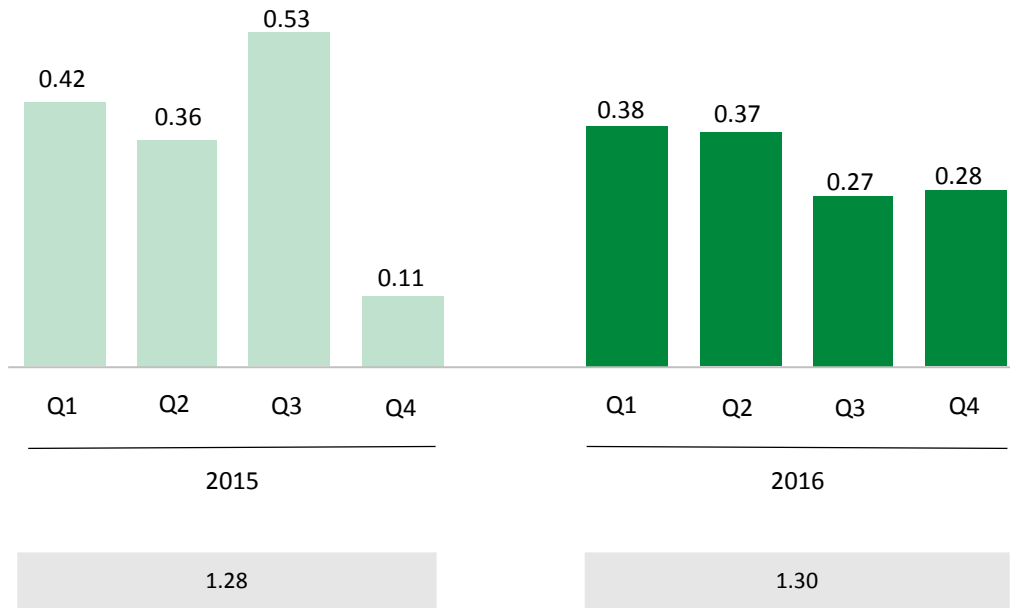

Earnings per common non-voting share (ProForma)

in EUR

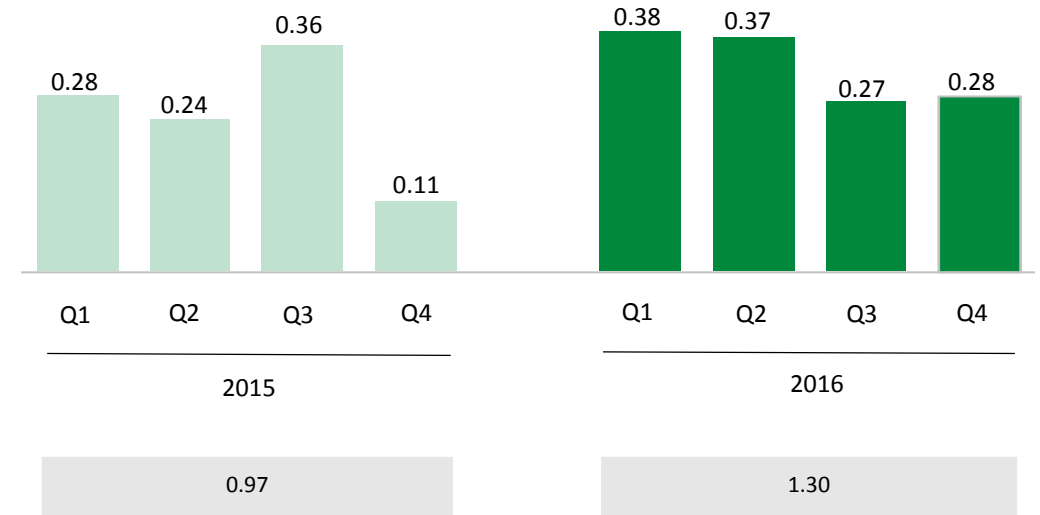

Corporate structure (simplified)

as of December 31, 2016

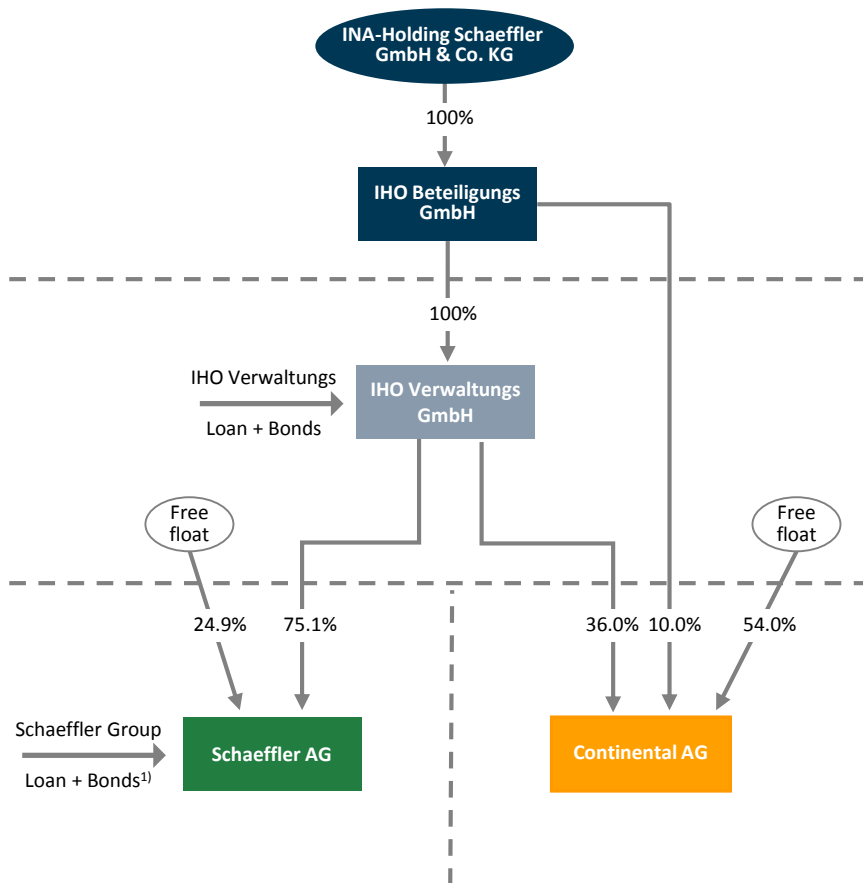

1) All outstanding bonds are issued by Schaeffler Finance B.V., a 100% subsidiary of Schaeffler AG.

Financing Structure

in EUR²⁾ mn, as of December 31, 2016

IHO Verwaltungs

	Debt instrument	Nominal (USD mn)	Nominal (EUR mn)	Interest	Maturity	Rating
Loans	Term loan (EUR)	-	425	E+2.75%	Sep-21	not rated
	RCF (EUR 200 mn)	-	-	E+2.75%	Sep-21	not rated
Bonds	2.75% SSNs 2021 (EUR)	-	750	2.75%	Sep-21	Ba1/BB-
	4.125% SSNs 2021 (USD)	500	474 ²⁾	4.125%	Sep-21	Ba1/BB-
	3.25% SSNs 2023 (EUR)	-	750	3.25%	Sep-23	Ba1/BB-
	4.50% SSNs 2023 (USD)	500	474 ²⁾	4.50%	Sep-23	Ba1/BB-
	3.75% SSNs 2026 (EUR)	-	750	3.75%	Sep-26	Ba1/BB-
	4.75% SSNs 2026 (USD)	500	474 ²⁾	4.75%	Sep-26	Ba1/BB-
Total			4,098	3.66%		

Schaeffler Group

	Debt instrument	Nominal (USD mn)	Nominal (EUR mn)	Interest	Maturity	Rating
Loans	Term loan (EUR)	-	1,000	E+1.45%	Jul-21	not rated
	RCF (EUR 1,300 mn)	-	-	E+1.05%	Jul-21	not rated
Bonds	2.50% SSNs 2020 (EUR)	-	400	2.50%	May-20	Baa3/BB+
	4.25% SSNs 2021 (USD)	700	664 ²⁾	4.25%	May-21	Baa3/BB+
	3.50% SSNs 2022 (EUR)	-	500	3.50%	May-22	Baa3/BB+
	4.75% SSNs 2023 (USD)	600	569 ²⁾	4.75%	May-23	Baa3/BB+
	3.25% SSNs 2025 (EUR)	-	600	3.25%	May-25	Baa3/BB+
Total			3,733	3.16%		

2) EUR/USD = 1.0540