



# Schaeffler Romania

*Together we move the world*

Official presentation

# The Schaeffler Group

## General Information

SCHAEFFLER

**Employees**  
worldwide: Around 76.000

**Sales (FY 2011)**  
worldwide: Around € 10,7 billion

**180 locations**  
in over 50 countries

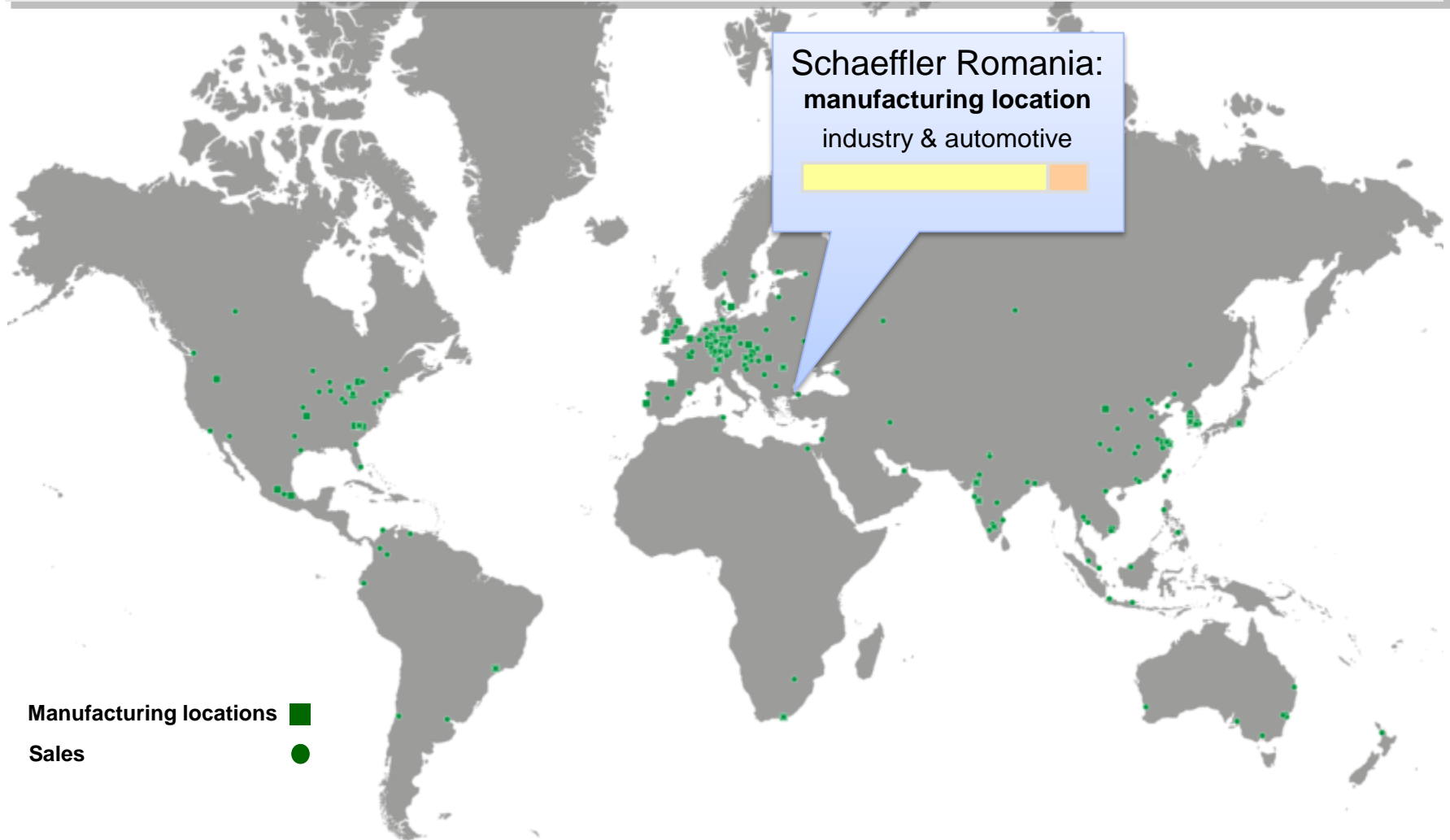

# Romania

## General information

### Country data

<b>Population:</b>	<b>19.599.506</b>
<b>Total area:</b>	<b>238.391 km<sup>2</sup></b>
<b>Currency:</b>	<b>1 EUR = 4.37 RON (01.02.2013)</b>
<b>GDP per capita in 2011:</b>	<b>€ 6.500</b>
<b>Member of:</b>	<b>UN, NATO, OSZE and EU</b>

### Investments

- ▶ **Schaeffler Romania**
- ▶ **Renault**
- ▶ **Ford**
- ▶ **Continental**
- ▶ **Lisa Dräxlmaier**
- ▶ **Honeywell**
- ▶ **Schneider&Oechsler International**



# The Braşov region

## General Information

SCHAEFFLER

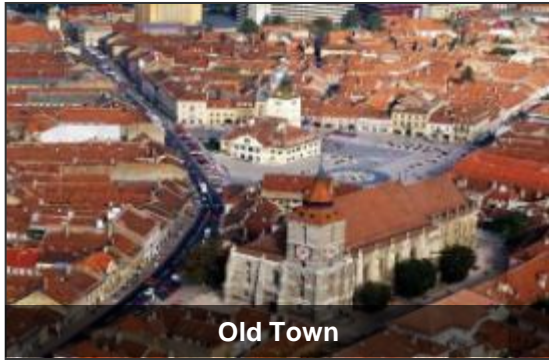

Old Town



Ecaterina Gate



University Transilvania



Black Church



View

- ▶ 10 years ago: reasons for choosing Braşov
- ▶ Bearing industry since 1949
- ▶ Qualified work force
- ▶ University Transilvania
- ▶ Support from local authorities
- ▶ Competent suppliers

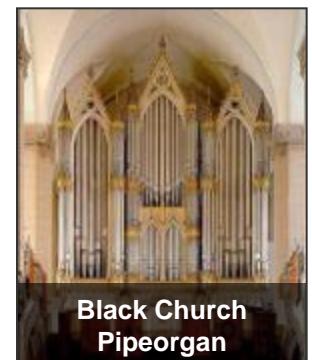

Black Church  
Pipeorgan



Bran Castle



White Watchtower



Council Square

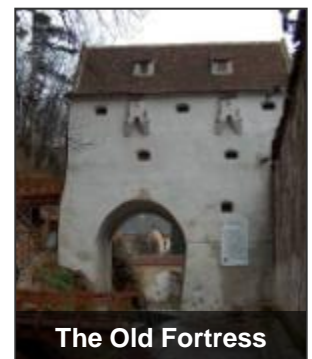

The Old Fortress

# The Schaeffler Romania project

## Development stages

The initial project of three production buildings has long since been surpassed. Today, after an investment of more than 500 million EUR, a developed area of 100.000 sqm and more than 3.500 employees, Schaeffler Romania runs production in 6 halls.

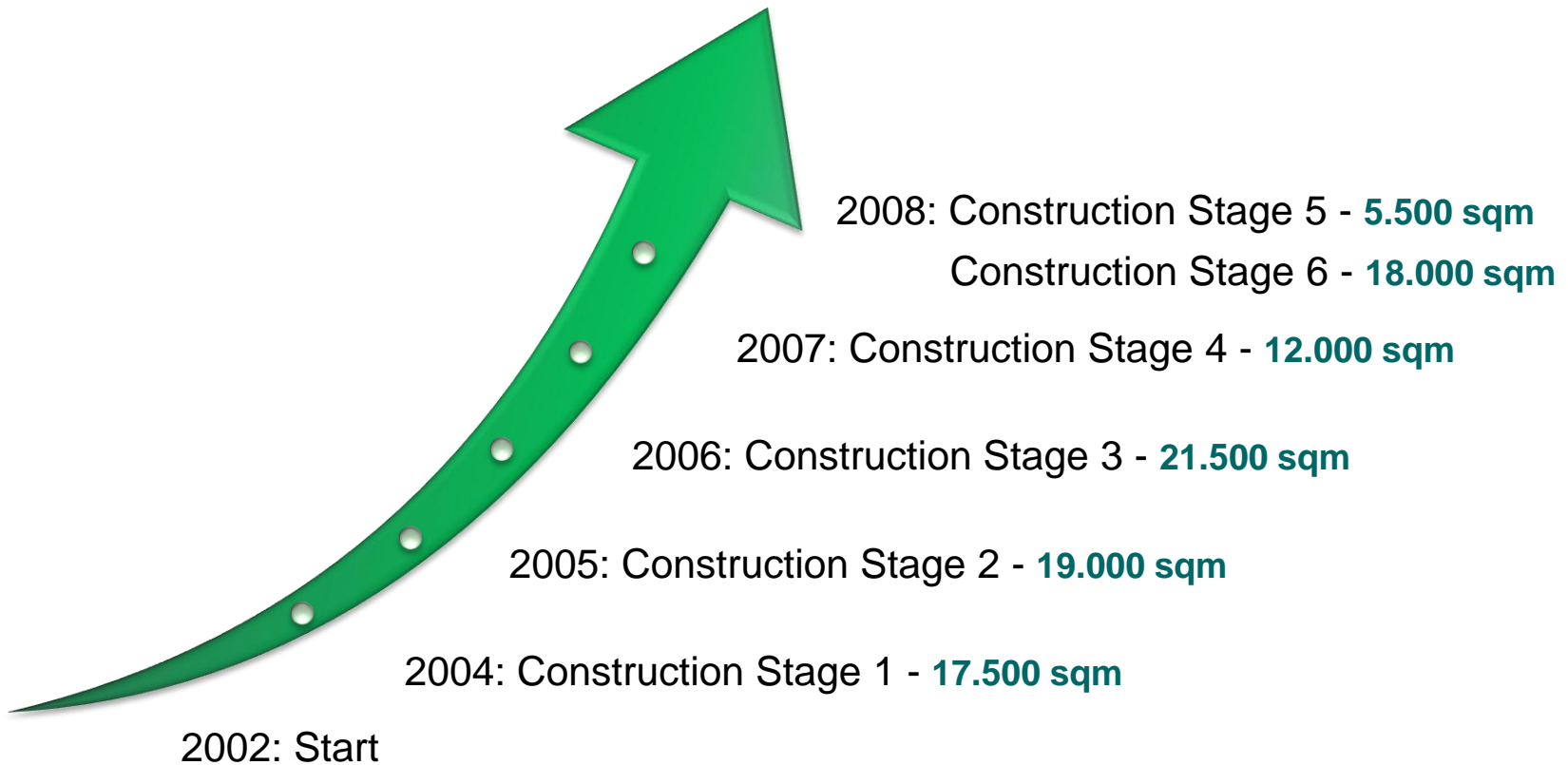

# Schaeffler Romania

## History

SCHAEFFLER

**2002**

Founding of INA-Schaeffler Braşov LTD. Start of production in a rented building. The first 100 employees.

**2004**

Relocation and start of production in the new plant in Cristian. Employees: 652

**2005**

Official inauguration of the first Schaeffler building in Romania. TUEV and Environment accreditations.

**2006**

Start of activity in the Training Workshop: apprenticeships, perfecting courses and professional reconversion courses.



**2007**

The first large sized bearing is produced in Schaeffler Romania.

**2008**

The first slewing ring in the Schaeffler Group is produced in Schaeffler Romania.

**2009**

Inauguration of the forge. The forge has a capacity for rings with diameters of up to 3 m.

**2012**

Inauguration of the Engineering Center Schaeffler

# Schaeffler Romania

## Layout – Overview of Construction Stages (CS)

SCHAEFFLER

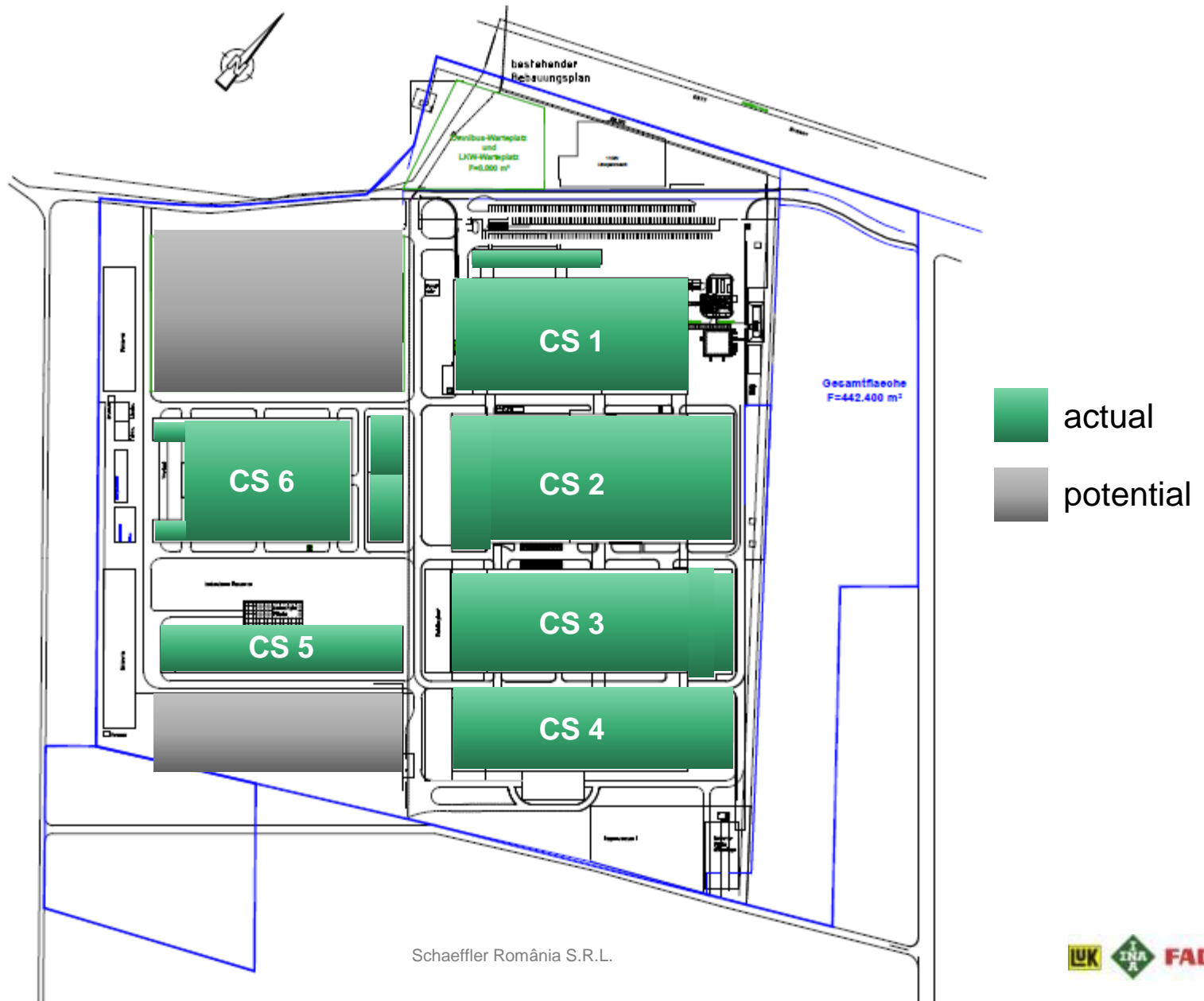

# Schaeffler Romania

## Development 1/7

SCHAEFFLER

july 2003

april 2004

april 2005

april 2006

april 2007

april 2008

april 2011





# Schaeffler Romania

## Development 2/7

SCHAEFFLER

july 2003

april 2004

april 2005

april 2006

april 2007

april 2008

april 2011



# Schaeffler Romania

## Development 3/7

SCHAEFFLER

july 2003

april 2004

april 2005

april 2006

april 2007

april 2008

april 2011



# Schaeffler Romania

## Development 4/7

SCHAEFFLER

july 2003

april 2004

april 2005

april 2006

april 2007

april 2008

april 2011



# Schaeffler Romania

Development 5/7

SCHAEFFLER

july 2003

april 2004

april 2005

april 2006

april 2007

april 2008

april 2011



# Schaeffler Romania

Development 6/7

SCHAEFFLER

july 2003

april 2004

april 2005

april 2006

april 2007

april 2008

april 2011



# Schaeffler Romania

## Development 7/7

SCHAEFFLER



july 2003    april 2004    april 2005    april 2006    april 2007    april 2008    april 2011

**Employees**  
**3.500**

**Investment**  
**530 Mio**

**Production area**  
**100.000 sqm**

**Products**  
**15**



# Schaeffler Romania

## Products – Application range

SCHAEFFLER

### Industry

85%



Tapered roller bearings



Spherical roller bearings



Cylindrical roller bearings



Linear technology



### Automotive

15%

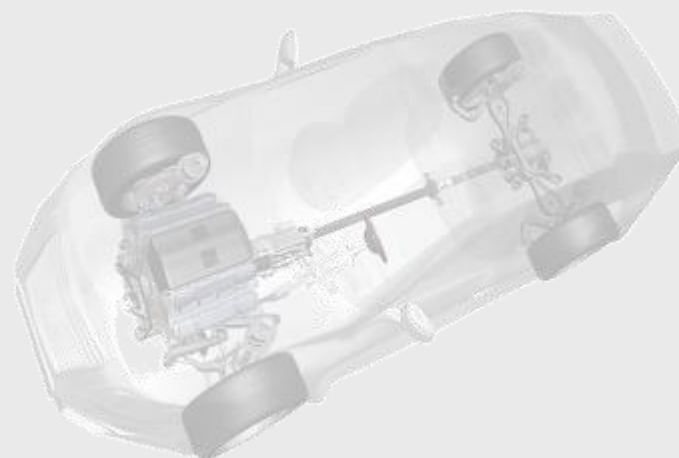

VCT



RSTO





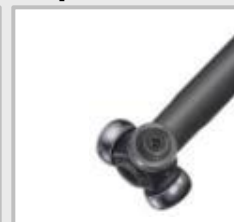



Tripod rollers









# Schaeffler Romania

## Products / Segments

SCHAEFFLER

Segment G	Segment E	Segment T	Segment U	Segment J	Segment H	Segment K
						
Cylindrical roller bearings	Spherical roller bearings	Tapered roller bearings	Spherical plain bearings	Forge	Large size bearings	Slewing rings
< 1.600 mm	< 1.600 mm	< 1.600 mm		< 3.000 mm	> 1.600 mm	< 4.200 mm

Segment D	Segment F	Segment V	Segment C	Segment N	Segment Y	Segment A
						
Tripod rollers	RSTO tappets	VCT (variable camshaft timer)	Brass Cages	Cylindrical roller bearings	Heat treatment	Linear guides
			40-1.600 mm	90-200 mm	< 3.200 mm	

Production Unit 1	Production Unit 2	Production Unit 3	Production Unit 4
-------------------	-------------------	-------------------	-------------------



# Schaeffler Rumänien

## Team & Organisation

SCHAEFFLER

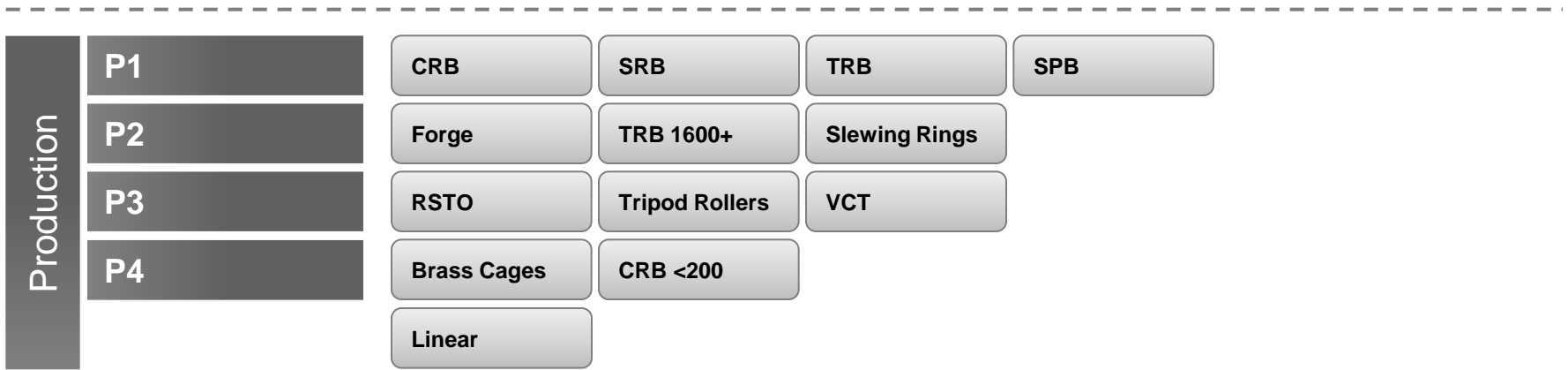
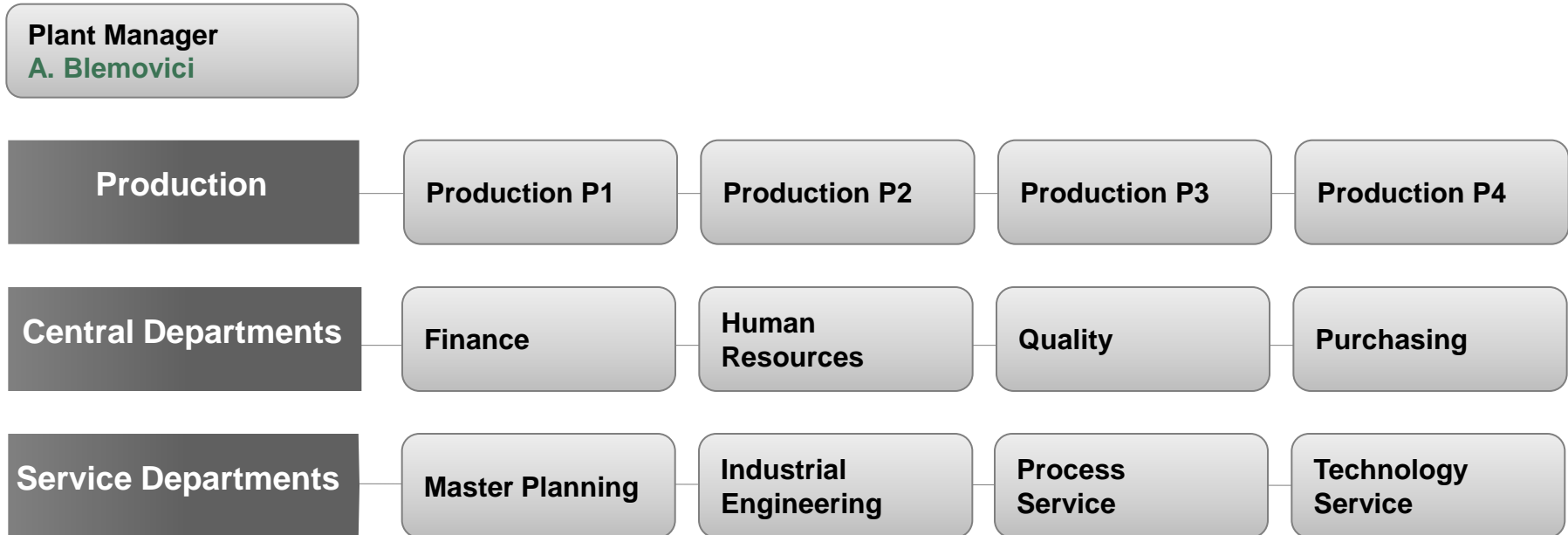

### MOVE & Fit for Quality

- Quality has the Highest Priority
- MOVE Academy & programs

Together we  
**move**  
the world



### Top international standards

- ISO 14001
- OHSAS 18001
- EMAS
- ISO / TS 16949 : 2009
- ISO 9001 : 2008

### Research and Development



Engineering Center Schaeffler Romania

### Employee Development

- Increasing the level of qualification
- Adapting the dual professional education: Deutsche Berufsschule
- Multiple programs with the University involving students, departments, PhD students, R&D projects



# Schaeffler Romania

## Engineering Center

SCHAEFFLER

### ▶ Research & Development

- ▶ Today: parts of R&D Projects, limited technical responsibility
- ▶ Future: Entire R&D projects, R&D Projects with clients, technical responsibility for more products

### ▶ Technical Calculations

- ▶ Today: only engine systems
- ▶ Future: Luk products, industry products

### ▶ Analysis and Benchmarking

- ▶ Today: failure analysis for engine systems; benchmarking - chaindrives
- ▶ Future: competence center for the entire Schaeffler Group

### ▶ CAD-Methods and Support

- ▶ Today: Support for Brasov, support for product lines in KBE-projects
- ▶ Future: Support for further locations complete template design for the KBE

2012  
95 employees

**Today:** ▶ ~ 3,2 mio Euro  
▶ total Space: 6.000 qm (EC: 3.000 qm)  
**Future:** ▶ 2013: ~140 employees, 2014: ~250 employees



### University

- ▶ CONAT FISITA main sponsor (2004, 2010)
- ▶ 2 Schaeffler laboratories
- ▶ 10 annual "Excellence Scholarships" for top students
- ▶ Supporting various projects, like the Formula Student Team

### Investing in future generations



- ▶ Increasing the level of qualification
- ▶ Adapting the dual professional education: German Vocational School Kronstadt



### Social projects

- ▶ more than 140 cultural, educational and social projects in 8 years
- ▶ Special programs for and with our employees



### The Schaeffler Park

- ▶ 2007 – first involvement
- ▶ 2011 – concept competition



### National awards and titles

- ▶ Most Admired Company BBV (2003)
- ▶ Award – Ministry of Foreign Affairs (2004)
- ▶ Award from the President of Romania (2005)
- ▶ Award from the IHK (2006)
- ▶ Manager of the year award (2010)
- ▶ Award for top exporter from in Brasov (2009, 2010, 2011)

**Schaeffler Romania**  
Thank you for your interest.

**SCHAEFFLER**

